

495/495P SPECTRUM ANALYZER

Qservice ----- This document is a complete scan from the original manual ----- Qservice

Please Check for CHANGE INFORMATION at the Rear of This Manual

First Printing MAY 1986

Tektronix[®]
COMMITTED TO EXCELLENCE

Copyright © 1986 Tektronix, Inc. All rights reserved.
Contents of this publication may not be reproduced in
any form without the written permission of Tektronix, Inc.

Products of Tektronix, Inc. and its subsidiaries are
covered by U.S. and foreign patents and/or pending
patents.

TEKTRONIX, TEK, SCOPE-MOBILE, and  are
registered trademarks of Tektronix, Inc. TELEQUIP-
MENT is a registered trademark of Tektronix U.K.
Limited.

Printed in U.S.A. Specification and price change
privileges are reserved.

Tektronix, Inc.
P.O. Box 500
Beaverton, Oregon 97077

Serial Number

PREFACE

This manual is one of a set of product manuals for the TEKTRONIX 495 and programmable 495P Spectrum Analyzer. The manual describes the instrument installation and operation. These instructions assume a thorough knowledge of frequency domain analysis. The purpose of this manual is to explain the operation of the spectrum analyzer so that measurements will be meaningful whether made under adverse or laboratory conditions. The manual organization is shown in the Table of Contents. The manuals that are available now in addition to this Operators Manual are the

- 495/495P Service Manuals, Volume 1 and 2 (standard accessories) and
- 495P Programmers Manual (standard accessory for 495P only).

There will be two additional publications available shortly; 495/495P Operators Handbook (optional accessory), and a Programmers Reference Guide. For manual ordering information, contact your local Tektronix Field Office or representative or refer to the Accessories portion of the Replaceable Mechanical Parts list in the Service Manual, Volume 2.

Standards and Conventions Used

Most terminology is consistent with standards adapted by IEEE and IEC. A glossary of terms is provided in Appendix A. Abbreviations in the documentation are consistent with ANSI Y1.1-1972. GPIB functions conform to the IEEE 488-1978 Standard. Copies of ANSI and IEEE standards can be ordered from the Institute of Electrical and Electronic Engineers Inc.

Change/History Information

Any change information that involves manual corrections or additional information is located behind the tabbed Change Information page at the back of this manual.

History information, as well as the updated data, is combined within this manual when the page(s) is revised. A revised page is identified by a revision date located in the lower inside corner of the page.

Unpacking and Initial Inspection

Instructions for unpacking and preparing the instrument for use are described in Section 3.

Storage and Repackaging

Instructions for short- and long-term storage and instrument repackaging for shipment are described in Section 3.

TABLE OF CONTENTS

	Page		Page
PREFACE.....	i	Section 4 (continued)	
TABLE OF CONTENTS.....	ii	Correcting Numerical Entry Errors	4-2
LIST OF ILLUSTRATIONS	iv	Instrument Power Control and	
LIST OF TABLES.....	v	Frequency.....	4-3
SAFETY SUMMARY	vi	Frequency Span and Resolution.....	4-5
Section 1 GENERAL INFORMATION		Marker Functions	4-7
Product Overview	1-1	Display Parameters	4-14
Firmware Version and Error Message		Sweep	4-17
Readout	1-1	Digital Storage.....	4-19
Accessories	1-1	Display and General Purpose.....	4-21
Options	1-2	Front-panel Input/Output and GPIB.....	4-24
Section 2 SPECIFICATION		Rear-panel Input/Output and GPIB.....	4-26
Electrical Characteristics.....	2-1	Section 5 INSTRUMENT CHECK OUT	
Verification of Tolerance Values.....	2-1	Firmware Version and Error Message	
Frequency Related Characteristics	2-1	Readout.....	5-1
Amplitude Related Characteristics	2-4	Firmware Version.....	5-1
Input Signal Characteristics	2-8	Error Message Readout.....	5-1
Output Signal Characteristics.....	2-10	Preparation for Use	5-1
General Characteristics.....	2-11	1. Initial Turn On	5-1
Power Requirements.....	2-11	2. Calibrate Position, Center	
Environmental Characteristics.....	2-12	Frequency, Reference Level, and	
Physical Characteristics.....	2-13	Bandwidth	5-2
Section 3 PREPARATION FOR USE		Functional or Operational Check.....	5-3
Unpacking and Initial Inspection.....	3-1	Equipment Required.....	5-3
Installation.....	3-1	Preliminary Preparation.....	5-3
Rackmount Instrument.....	3-1	1. Check Operation of Front-Panel	
Rack Adapter Kit.....	3-2	Pushbuttons and Controls.....	5-3
Power Source and Power		2. Check Gain Variation Between	
Requirements	3-2	Resolution Bandwidths	5-10
Storage and Repackaging	3-2	3. Check Span Accuracy and	
Storage	3-2	Linearity	5-11
Repackaging for Shipment.....	3-2	4. Check Resolution Bandwidth and	
Transit Case.....	3-2	Shape Factor.....	5-11
Section 4 CONTROLS, CONNECTORS,		5. Check Reference Level Gain and	
AND INDICATORS		RF Attenuator Steps	5-12
Operating Modes.....	4-1	6. Check Sensitivity.....	5-12
Initial Entry Functions (Black Labels) ..	4-1	7. Check Residual FM.....	5-13
Multiple-Pushbutton Sequence		8. Check Frequency Drift or	
Functions (SHIFT Pushbuttons).....	4-1	Stability	5-13
Terminating Multiple-Pushbutton		9. GPIB Verification Program	5-13
Sequences	4-1	Section 6 OPERATION	
DATA ENTRY Functions (Orange		Instrument Operating Features.....	6-1
Labels)	4-2	Firmware Version and Error Message	
		Readout	6-1
		Crt Light Filters	6-1
		Intensity Level and Beam Alignment...	6-1
		Signal Application	6-1
		⚠ RF INPUT Connector.....	6-1

	Page
Section 6 (continued)	
Resolution Bandwidth, Frequency Span, and Sweep Time	6-2
Using the HELP Feature.....	6-3
Using the Signal Identifier.....	6-3
Using the Video Filters.....	6-4
Using Time Domain Operation	6-4
Triggering the Display.....	6-4
Sweeping the Display.....	6-5
Manual Scan of the Spectrum.....	6-5
Reference Level, RF Attenuation, and Vertical Display	6-5
Alternate Reference Level Units Selection	6-6
Using the Delta A Mode	6-6
Using MIN NOISE or MIN DISTORTION.....	6-6
Using Digital Storage	6-6
Using the Store and Recall Features ..	6-7
Using the Counter	6-8
Plotting the Display.....	6-8
Using the Markers Feature	6-8
Marker Terms	6-8
Marker Turn On.....	6-8
Marker Menu and Assign Menu	6-9
Assigning Markers	6-9
Tuning Markers	6-9
Error Detection.....	6-10
Using the Automatic Performance Testing Feature	6-10
Using the Tracking Generator Mode ..	6-10
Using the Sideband Analyzer Mode ..	6-10
Programming Features (495P GPIB Operation).....	6-11
Setting GPIB Address Switches.....	6-11
TALK ONLY, LISTEN ONLY Switches.....	6-11
Connecting to a System.....	6-11
Operational Considerations/Precautions	6-11
1.  RF INPUT Power Limit.....	6-11
2. Instrument Warm-up After Storage	6-11
3. Auto Resolution.....	6-11

	Page
Section 6 (continued)	
4. Level of Pulsed Signals.....	6-11
5. Level of Continuous Wave Signals.....	6-12
6. Excessive Input Signal Level.....	6-12
7. No Crt Trace	6-12
8. PEAK/AVERAGE.....	6-12
9. Digital Storage Effects on Signal Analyses.....	6-12
10. Stored Display Averaged in Wide Spans	6-12
11. Automatic Calibration of Relative Amplitudes of Resolution Bandwidth Filters	6-12
12. TRIGGERING	6-12
Service Information	6-12
Service Manual.....	6-12
Product Service.....	6-13
Emergency Repair.....	6-13
Maintenance Agreements.....	6-13
Section 7 OPTIONS	
Options A1–A5 (Power Cord Options).....	7-1
Options M1–M3 (Extended Service and Warranty Options)	7-1
Option 05 (Provides frequency counter and macros).....	7-2
Option 07 ! (Provide 75Ω Input).....	7-2
Options 30 and 31 (Provide Rackmount).....	7-3
Option 39 (Provide Silver Battery).....	7-5
Option 42 (Provide 110 MHz IF Output)	7-5
Option 45 (Provide MATECO Capability)	7-5
Option 52 (Provide North American 220 V).....	7-5
Appendix A GLOSSARY	
General Terms.....	A-1
Terms Related to Frequency	A-1
Terms Related to Amplitude	A-2
Terms Related to Digital Storage.....	A-3
Terms Related to Markers.....	A-3

LIST OF TABLES

Table Number	Page	Table Number	Page
2-1	Frequency Related Characteristics.....	2-1	
2-2	Amplitude Related Characteristics.....	2-4	
2-3	Input Signal Characteristics.....	2-8	
2-4	Output Signal Characteristics.....	2-10	
2-5	General Characteristics.....	2-11	
2-6	Power Requirements.....	2-11	
2-7	Environmental Characteristics.....	2-12	
2-8	Physical Characteristics.....	2-13	
5-1	Sensitivity.....	5-12	
6-1	50 Ω System Reference Level Conversion.....	6-2	
6-2	Marker Trace Organization.....	6-10	
7-1	Power Cord Options.....	7-1	
7-2	Extended Service and Warranty Options.....	7-2	
7-3	Option 07 Alternate Specifications.....	7-2	
7-4	Options 30 and 31 Characteristics and Alternate Specifications.....	7-4	
7-5	Option 42 Alternate Specifications.....	7-5	

LIST OF ILLUSTRATIONS

Figure Number	Page	Figure Number	Page
2-1	Dimensions.....	2-15	
4-1	Instrument Power Control and Frequency.....	4-3	
4-2	Frequency Span and Resolution.....	4-5	
4-3	Marker Functions.....	4-7	
4-4	Locating the signal peak.....	4-8	
4-5	Using <green-SHIFT> PEAK FIND.....	4-10	
4-6	Signal finding example.....	4-11	
4-7	Signal finding example.....	4-12	
4-8	Signal finding example.....	4-12	
4-9	Signal finding example.....	4-13	
4-10	Signal finding example.....	4-13	
4-11	Display Parameters.....	4-14	
4-12	Sweep.....	4-17	
4-13	Digital Storage.....	4-19	
4-14	Display and General Purpose.....	4-21	
4-15	Front-Panel Input/Output and GPIB.....	4-24	
4-16	Rear-Panel Input/Output and GPIB.....	4-26	
5-1	Crt display and readout at initial turn on.....	5-1	
5-2	Typical display of calibration markers in the maximum span position.....	5-2	
5-3	Integrating a display with the VIDEO FILTER.....	5-5	
5-4	Using the IDENT feature to identify a real or true response.....	5-6	
5-5	Displays that illustrate how bandwidth and shape factor are determined.....	5-11	
5-6	Typical display showing how to determine residual FM.....	5-14	
6-1	Circuit of a 75 to 50 Ω matching pad (ac coupled).....	6-2	
6-2	Graph illustrating the relationship between dBm, dBmV, and dB.....	6-2	
6-3	Volts-dBm-Watts conversion chart for 50 Ω impedance.....	6-3	
6-4	Typical example of Identifier mode displays.....	6-4	
6-5	Typical display mixed with the VIDEO FILTER.....	6-5	
6-6	Typical display using B-SAVE A to observe the difference between SAVE A and B displays.....	6-7	
7-1	International power cord options for the spectrum analyzer.....	7-1	

SAFETY SUMMARY

(Refer all servicing to qualified servicing personnel)

The safety information in this summary is for both operating and servicing personnel. Specific warnings and cautions will be found throughout the manual where they apply, but may not appear in this summary.

CONFORMANCE TO INDUSTRY STANDARDS

This instrument complies with the following Industry Safety Standards and Regulatory Requirements.

Safety

CSA: Electrical Bulletin

FM: Electrical Utilization Standard Class 3820

ANSI C39.5 — Safety Requirements for Electrical and Electronic Measuring and Controlling Instrumentation.

IEC 348 (2nd edition) — Safety Requirements for Electronic Measuring Apparatus.

Regulatory Requirements

VDE 0871 Class B — Regulations for RFI Suppression of High Frequency Apparatus and Installations.

TERMS

In This Manual

CAUTION statements identify conditions or practices that could result in damage to the equipment or other property.

WARNING statements identify conditions or practices that could result in personal injury or loss of life.

As Marked on Equipment

CAUTION indicates a personal injury hazard not immediately accessible as one reads the marking, or a hazard to property, including the equipment itself.

DANGER indicates a personal injury hazard immediately accessible as one reads the marking.

SYMBOLS

In This Manual



This symbol indicates where applicable cautionary or other information is to be found.

As Marked on Equipment



DANGER — High voltage.



Protective ground (earth) terminal.



ATTENTION — refer to manual.



Refer to manual

POWER

Power Source

This product is intended to operate from a power source that will not apply more than 250 V rms between the supply conductors or between either supply conductor and ground. A protective ground connection by way of the grounding conductor in the power cord is essential for safe operation.

Grounding the Product

This product is grounded through the grounding conductor of the power cord. To avoid electrical shock, plug the power cord into a properly wired receptacle before connecting it to the product input or output terminals. A protective ground connection by way of the grounding conductor in the power cord is essential for safe operation.

Danger From Loss of Ground

Upon loss of the protective-ground connection, all accessible conductive parts (including knobs and controls that may appear to be insulating) can render an electric shock.

Use the Proper Power Cord

Use only the power cord and connector specified for your product.

Use only a power cord that is in good condition.

Refer cord and connector changes to qualified service personnel.

For detailed information on power cords and connectors, see the Maintenance section in the Service Manual, Volume 1.

Use the Proper Fuse

To avoid fire hazard or equipment damage, use only the fuse of correct type, voltage rating, and current rating for your product (as specified in the Replaceable Electrical Parts list in Volume 2 of the Service Manual). Refer fuse replacement to qualified service personnel.

OPERATIONAL PRECAUTIONS

Do Not Operate in Explosive Atmospheres

To avoid explosion, do not operate this product in an explosive atmosphere unless it has been specifically certified for such operation.

Do Not Remove Covers or Panels

To avoid personal injury, do not remove the product covers or panels unless you are qualified to do so. Do not operate the product without the covers and panels properly installed.

Dangerous voltages exist at several points in this product. To avoid personal injury, do not touch exposed connections and components while power is on. REFER ALL SERVICING TO QUALIFIED SERVICE PERSONNEL.

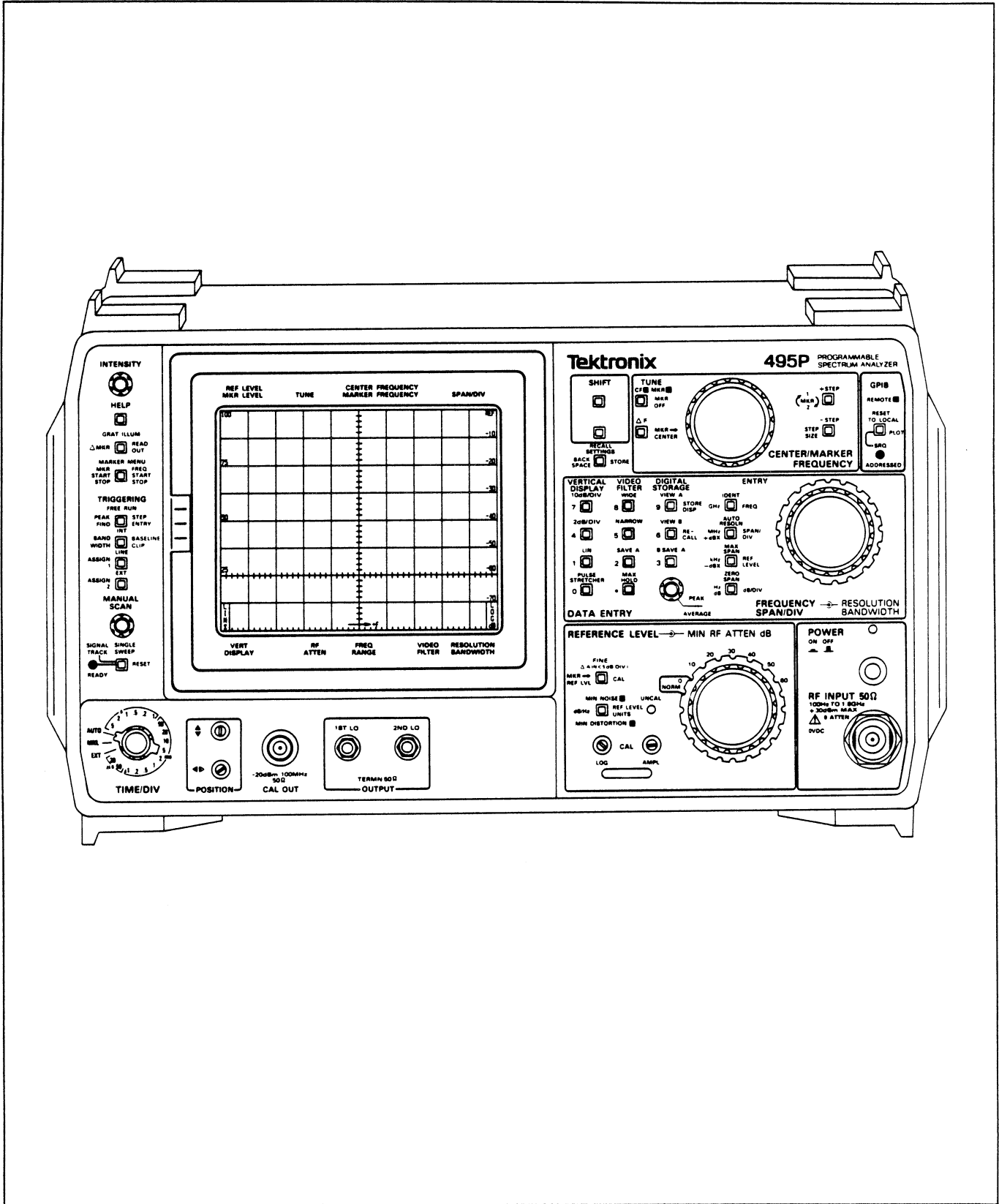

TEKTRONIX 495P Programmable Spectrum Analyzer

*This Document is a complete Scan from the original
Tektronix manual
For enquiries about our complete
High quality line of technical Manuals in PDF
mailto : Qservice@otenet.gr*

**SEE
OTHER
SIDE**

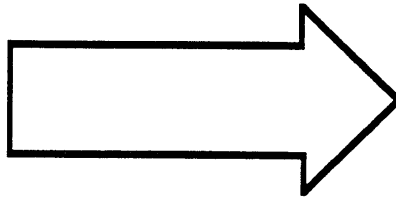

GENERAL INFORMATION

PRODUCT OVERVIEW

The TEKTRONIX 495 and programmable 495P Spectrum Analyzers are high performance, compact, portable instruments. Microcomputer control of most functions simplifies and enhances operation.

The following is a list of the main instrument features.

- single and delta marker modes
- synthesizer frequency accuracy
- precise amplitude measurement capability
- digital storage display
- internal memory to retain front-panel settings and displays
- HELP message crt readout that describes the function of front-panel pushbuttons and controls as well as messages that explain operating errors
- front-panel DATA ENTRY pushbuttons
- ability to plot the display and graticule

The frequency range is 100 Hz to 1800 MHz. A minimum resolution bandwidth of 30 Hz, with a minimum span of 50 Hz/div, provides measurement resolution that is proportional to the frequency accuracy. Digital storage provides flicker-free displays plus SAVE A, B—SAVE A, and MAX HOLD to compare and subtract displays and save maximum values. In addition to conventional digital storage features, internal memory stores up to nine separate displays with their readouts and dot markers, which can be recalled later for additional analysis and comparison. It is also possible to store up to ten different front-panel control setups for future recall.

Select center frequency either by the front-panel CENTER/MARKER FREQUENCY control or by the Data Entry pushbuttons. When using the Data Entry pushbuttons, it is not necessary to alter the Span/Div setting regardless of the frequency selected. Other parameters, such as vertical display and reference level, are pushbutton selectable with the flexibility previously available only under program control of the general purpose interface bus (GPIB).

The single and delta markers provide direct readout of frequency and amplitude information of any point along any displayed trace. Relative (delta) frequency and amplitude information between any two points along any displayed trace or between traces is also available. The CENTER/MARKER FREQUENCY control can move the markers, or it can move the display with a stationary frequency marker. For additional marker information, refer to Using the Markers Feature in Section 6 of this Manual.

The programmable version of the instrument adds remote control capabilities to the manual instrument features. The front-panel controls (except those intended exclusively for local use, such as INTENSITY) can be remotely operated through the GPIB port, which allows the spectrum analyzer to be used with a variety of systems and controllers. Refer to the Programmers Manual for additional information.

Firmware Version and Error Message Readout

This feature of the spectrum analyzer provides readout that identifies the version of firmware installed. The readout is momentarily displayed when the power is turned on. All front-panel lights will temporarily flash on when the power is first turned on. In addition, the programmable instrument will flash that information and the GPIB address when RESET TO LOCAL is pressed.

If the spectrum analyzer fails to complete any routine or function, an error message will flash on the screen explaining the failure.

Accessories

The Replaceable Mechanical Parts list in the Service Manual, Volume 2, contains the part numbers, descriptions, and ordering information for all standard and optional accessories offered for the spectrum analyzer at this time.

The following list includes all standard accessories currently shipped with each instrument. Refer to Options 30 and 31 in the Options section of this manual for alternate information.

- 50 Ω coaxial cable; N to N connector, 72 inch
- 50 Ω coaxial cable; bnc to bnc connector, 18 inch
- Adapter; N male to bnc female
- 4A fast-blow fuses¹; 2 each
- Power cord¹
- Cord clamp
- Crt light filters; 2 – one each amber and grey
- Crt mesh filter
- Rear Connector Shield

¹ If the instrument is wired for 220-240 V operation (Options A1, A2, A3, A4, A5) or if Option 52 is installed (North American configuration for 220 V with standard power cord), 2A medium-blow fuses are used.

General Information — 495/495P Operators

- 495/495P Operators Manual
- 495/495P Service Manual, Volume 1
- 495/495P Service Manual, Volume 2
- 495P Programmers Manual; 495P Only

Options

The Options section of this Manual contains information on all of the options currently available for the spectrum analyzer.

SPECIFICATION

This section includes the electrical, physical, and environmental characteristics of this instrument. Any instrument specification changes due to options are listed in the Options section of this manual.

ELECTRICAL CHARACTERISTICS

The following tables of electrical characteristics and features apply to the Spectrum Analyzer after a 30-minute warmup and after doing the front-panel CAL adjustments, except as noted. The Performance Requirement statements define characteristics that are essential to the intended application of the product. Performance Requirement characteristics are normally verifiable by following the Performance Check procedure in the Service Manual, Volume 1. The Supplemental Information column provides more explanation about related Performance Requirements, or describes typical performance for characteristics not ordinarily verified by the Performance Check procedure.

The instrument performs an internal processor system check each time power is turned on. The Functional or Operational Check procedure, which does not require external test equipment or technical expertise, is provided in Section 5 of this manual. This procedure will satisfy most incoming inspections and will help familiarize you with the instrument capabilities.

Verification of Tolerance Values

Perform compliance tests of specified limits, listed in the Performance Requirement column, only after a 30-minute warm-up time (except as noted) and after doing the front-panel CAL procedure. Use measurement instruments that do not affect the values measured. Measurement tolerance of test equipment should be negligible when compared to the specified tolerance and when not negligible, add the error of the measuring device to the specified tolerance.

Table 2-1
FREQUENCY RELATED CHARACTERISTICS

Characteristic	Performance Requirement	Supplemental Information
Center Frequency Range		100 Hz–1800 MHz Tuned by the CENTER/MARKER FREQUENCY control or the DATA ENTRY pushbuttons.
Accuracy (after front-panel CAL has been performed)		Center Frequency Accuracy is specified by two characteristics: <ul style="list-style-type: none"> • initial accuracy (set between sweeps) • center frequency drift during the sweep
1st LO Unlocked (Span/Div > 200 kHz)	$\pm \{(20\%D) + (CF \times 10^{-5})^a + 15 \text{ kHz}\}$ Where: D = SPAN/DIV or RESOLUTION BANDWIDTH, whichever is greater CF = Center Frequency	Allow a settling time of one second for each GHz change in CF.

^aOver the operating temperature range this term is $(CF \times 1.5 \times 10^{-6})$

Table 2-1 (Continued)
FREQUENCY RELATED CHARACTERISTICS

Characteristic	Performance Requirement	Supplemental Information
Initial Accuracy (Continued) 1st LO Phase Locked (Span/div ≤200 kHz)	$\pm \{(20\%D) + (CF \times 10^{-5})^a 15 \text{ Hz}\}$ Where: D = SPAN/DIV or RESOLUTION BANDWIDTH, whichever is greater CF = Center Frequency	
Drift		With constant ambient temperature and fixed center frequency.
After 30 minute warm up 1st LO Unlocked (Span/div >200 kHz)		Typically ≤25 kHz per minute.
1st LO Locked (Span/div ≤200 kHz)		Typically ≤150 Hz per minute.
After 1 hour warm up 1st LO Unlocked (Span/div >200 kHz)		Typically ≤5 kHz per minute. Not significant when compared to Residual FM per minute of sweep time.
1st LO Locked (Span/div ≤200 kHz)	≤50 Hz per minute	Correction will occur at the end of sweep for sweep times ≥5 s/div
Readout Resolution		At least 10% of SPAN/DIV to minimum of 1 Hz.
Residual FM 1st LO Unlocked (Span/div >200 kHz)	≤7 kHz total excursion in 20 ms	Short term, after 1 hour warm up.
1st LO Locked (Span/div ≤200 kHz)	≤10 Hz total excursion in 20 ms	
Static Resolution Bandwidth (6 dB down)	Within 20% of selected bandwidth	30 Hz, then 100 Hz to 1 MHz in decade steps.
Shape Factor (60 dB/6 dB) 30 Hz Resolution Bandwidth	12:1 or less	
Other Bandwidths	7.5:1 or less	
Noise Sidebands	At least -75 dBc at an offset of $30 \times$ resolution bandwidth (-70 dBc for resolution bandwidth ≤100 Hz)	

^aOver the operating temperature range this term is $(CF \times 1.5 \times 10^{-5})$

Table 2-1 (Continued)
FREQUENCY RELATED CHARACTERISTICS

Characteristic	Performance Requirement	Supplemental Information
Video Filter Narrow		Reduces video bandwidth to approximately 1/300th of the selected resolution bandwidth and 1/100th for 30 Hz bandwidth (0.3 Hz).
Wide		Reduces video bandwidth to approximately 1/30th of the selected resolution bandwidth and 1/10th for 30 Hz bandwidth (3 Hz).
Pulse Stretcher Fall Time		30 μ s/div of pulse amplitude.
Frequency Span/Div Range		20 Hz/div to 100 MHz/div (in a 1-2-5 sequence with SPAN/DIV) or to 170 MHz/div (by two significant digits from the DATA ENTRY pushbuttons). Also, MAX SPAN provides a full band display, and ZERO SPAN provides a 0 Hz display. With ZERO SPAN the horizontal axis is calibrated in time/div instead of frequency/div.
Accuracy/Linearity	Within 5% of the selected Span/Div	Measured over the center 8 divisions of the display.
Frequency Response and Display Flatness About the midpoint between two extremes	± 1.0 dB	Frequency response is measured with 10 dB of RF attenuation. Response is affected by: <ul style="list-style-type: none"> • input vswr • gain variation • mixer conversion Refer to Options 30 and 31 in the Options section for alternate specification.
Marker(s)		When activated, the marker is a bright dot positioned by the CENTER/MARKER FREQUENCY control or the DATA ENTRY pushbuttons.
Normal Accuracy/Resolution	Identical to that for center frequency	For the live trace.

Table 2-1 (Continued)
FREQUENCY RELATED CHARACTERISTICS

Characteristic	Performance Requirement	Supplemental Information
Marker(s) (Continued) Δ MKR Accuracy	±1% of the total span	For the live trace. ΔMKR activates a second marker at the position of the single marker on the trace. Parenthesis appear on the marker display line indicating that the delta mode is active. The display shows the difference in frequency and amplitude. 1←MKR→2 selects which marker is tuned.
Δ MKR Resolution		At least 10% of Span/Div

Table 2-2
AMPLITUDE RELATED CHARACTERISTICS

Characteristic	Performance Requirement	Supplemental Information
Vertical Display Modes		10 dB/Div, 2 dB/Div, and Linear — any integer between 1–15 dB/Div can also be selected with the DATA ENTRY pushbuttons.
Reference Level (top of graticule) Range Log Mode		From -117 dBm to +40 dBm; +40 dBm includes 10 dB of IF gain reduction (+30 dBm is the maximum safe input). Alternate reference levels are: <ul style="list-style-type: none"> • dBV (-130 dBV to +27 dBV) • dBmV (-70 dBmV to +87 dBmV) • dBμV (-10 dBμV to +147 dBμV)
Linear Mode		39.6 nV/Div–2.8 V/Div (Maximum safe input level is 1 W cw or 10 V peak)
Steps 10 dB/div Log Mode		10 dB for the Coarse Mode 1 dB for the Fine Mode
2 dB/div Log Mode		1 dB for the Coarse Mode 0.25 dB for the Fine Mode
Linear Mode		1-2-5 sequence for Coarse Mode 1 dB equivalent steps for Fine Mode

Table 2-2 (Continued)
AMPLITUDE RELATED CHARACTERISTICS

Characteristic	Performance Requirement	Supplemental Information
Reference Level (Continued) Set with DATA ENTRY push-buttons		Steps correspond to the display mode in coarse; except, for 2 dB/Div when the steps are 1 dB. In Fine Mode: 1 dB when the mode is 5 dB/div or more 0.25 dB for display modes of 4 dB/div or less (referred to as Delta A Mode)
Accuracy		Dependent on the following characteristics: <ul style="list-style-type: none"> ● RF Attenuation Accuracy ● IF Gain Accuracy ● Resolution Bandwidth ● Display Mode ● Calibrator Accuracy ● Frequency Response ● <blue-SHIFT> CAL routine reduces error between resolution bandwidths at -20 dBm REF LEVEL. Other reference levels may have larger errors. ● Ambient Temperature Change (± 0.15 dB/°C maximum, typically, ± 0.05 dB/°C) The input RF attenuator steps 10 dB for reference level changes above -30 dBm (-20 dBm when MIN NOISE is active) unless the MIN RF ATTEN setting is greater than zero. The IF gain increases 10 dB for each 10 dB reference level change below -30 dBm (20 dBm when MIN NOISE is active)
Display Dynamic Range		80 dB maximum for log mode 8 divisions for linear mode
Accuracy 10 dB/div Log Mode	± 1.0 dB/10 dB to a maximum cumulative error of ± 2.0 dB over 80 dB range	
2 dB/div Log Mode	± 0.4 dB/2 dB to a maximum cumulative error of ± 1.0 dB over 16 dB range	
Linear mode	$\pm 5\%$ of full scale	

**Table 2-2 (Continued)
AMPLITUDE RELATED CHARACTERISTICS**

Characteristic	Performance Requirement	Supplemental Information
RF Attenuator Range		0-60 dB in 10 dB steps
Accuracy Dc-1800 MHz	Within 0.5 dB/10 dB to a maximum of 1 dB over the 60 dB range	
Marker(s)		When activated, the marker is a bright dot positioned by the CENTER/MARKER FREQUENCY control.
Accuracy (Normal or Delta Mode)		Identical to REF LEVEL accuracy plus cumulative error of display scale (dependent on vertical position) ΔMKR activates a second marker at the position of the single marker on the trace. Parenthesis appear on the marker display line indicating that the delta mode is active. The display shows the difference in frequency and amplitude. 1←MKR→2 selects which marker is tuned.
Gain Variation Between Resolution Bandwidths		Measurement conditions: <ul style="list-style-type: none"> ● measured at -20 dBm ● minimum distortion Mode ● after front-panel CAL adjustments
With respect to 1 MHz Filter	< ±0.4 dB	
Between Any Two Filters	<0.8 dB	
IF Gain Range		87 dB of gain increase, 10 dB of gain decrease (MIN NOISE activated), in 10 dB and 1 dB steps. Steps are monotonic (all in the same direction).
Accuracy 1 dB Step	At least 0.2 dB/dB step to 0.5 dB/9 dB steps except at the decade transitions	
Decade Transitions -29 to -30 dBm -39 to -40 dBm -49 to -50 dBm -59 to -60 dBm	0.5 dB or less	Maximum 1 dB cumulative error over 10 dB
Maximum Deviation over the 97 dB Range	±2 dB	

Table 2-2 (Continued)
AMPLITUDE RELATED CHARACTERISTICS

Characteristic	Performance Requirement	Supplemental Information															
Differential Amplitude Measurement		Delta A Mode provides differential measurements in 0.25 dB increments. (This is not related to the Delta Marker Mode.)															
Range		Maximum range of 57.75 dB dependent on reference level when the Delta A Mode is activated.															
Accuracy		<table border="1"> <thead> <tr> <th>Difference</th> <th>Steps</th> <th>Error</th> </tr> </thead> <tbody> <tr> <td>0.25 dB</td> <td>1</td> <td>0.15 dB</td> </tr> <tr> <td>2 dB</td> <td>8</td> <td>0.4 dB</td> </tr> <tr> <td>10 dB</td> <td>40</td> <td>1.0 dB</td> </tr> <tr> <td>20 to 57.75 dB</td> <td>80 to 231 dB</td> <td>2.0 dB</td> </tr> </tbody> </table>	Difference	Steps	Error	0.25 dB	1	0.15 dB	2 dB	8	0.4 dB	10 dB	40	1.0 dB	20 to 57.75 dB	80 to 231 dB	2.0 dB
Difference	Steps	Error															
0.25 dB	1	0.15 dB															
2 dB	8	0.4 dB															
10 dB	40	1.0 dB															
20 to 57.75 dB	80 to 231 dB	2.0 dB															
Sensitivity Resolution Bandwidth 30 Hz 100 Hz 1 kHz 10 kHz 100 kHz 1 MHz	-130 dBm -125 dBm -115 dBm -105 dBm -95 dBm -85 dBm	Equivalent maximum input noise for each resolution bandwidth. Measured with: <ul style="list-style-type: none"> • 0 dB attenuation (MIN RF ATTEN dB 0) • NARROW VIDEO FILTER • 2 dB/DIV Log Mode • DIGITAL STORAGE On • MAX HOLD Off • PEAK/AVERAGE in Average • 1 SEC TIME/DIV • ZERO SPAN On • Input terminated in 50 Ω (See Option 07 in the Options section for alternate specifications.)															
Spurious Responses Residual	-100 dBm or less	No input signal (See Options 30 and 31 in the Options section for alternate specifications.)															
3rd Order Intermodulation Products	-70 dBc or less	Measured from any two on-screen signals within any frequency span. In Minimum Distortion Mode															
Zero Frequency Spur	-24 dBm or less	Referenced to input with 0 dB attenuation, terminated into 50 Ω and into open circuit. Measured at 25°C.															
Harmonic Distortion	-60 dBc or less	Measured across entire band, with -30 dBm input and 0 dB attenuation.															
LO Emission	-70 dBm or less	With 0 dB RF Attenuation.															

Table 2-3
INPUT SIGNAL CHARACTERISTICS

Characteristic	Performance Requirement	Supplemental Information
RF INPUT		Type N female connector. (See Option 07 in the Options section for supplemental specifications concerning an additional 75 Ω input.)
Impedance		50 Ω
VSWR with 10 dB or more RF Attenuation		1.3:1 maximum (typically 1.2:1)
VSWR with 0 dB RF Attenuation		2.0:1 maximum (typically 1.9:1)
Maximum Safe Input (With 0 dB RF attenuation)		+30 dBm (1 W) continuous, 75 W peak, pulse width 1 μs or less with a maximum duty factor of 0.001 (attenuator limit). DO NOT APPLY DC VOLTAGE TO THE RF INPUT.
1 dB Compression Point	-20 dBm	With no RF attenuation. Measured at 10 MHz IF output. Minimum Distortion mode. (-10 dBm in Min Noise mode.) No gain compression can be displayed on the screen.
HORIZ TRIG (Rear Panel)		Dc coupled input for external horizontal drive (selected by the EXT position of the front-panel TIME/DIV control) and ac coupled input for external trigger signals (selected at other positions of the TIME/DIV control).
Sweep Input Voltage Range		0 to +10V (dc + peak ac) for full screen deflection
Trigger Input Voltage Range Minimum	At least 1.0V peak from 15 Hz to 1 MHz	
Maximum dc + peak ac		50V
ac		30V _{rms} to 10 kHz, then derate linearly to 3.5V _{rms} at 100 kHz and above.
Pulse Width		0.1 μs minimum

Table 2-3 (Continued)
INPUT SIGNAL CHARACTERISTICS

Characteristic	Performance Requirement	Supplemental Information
MARKER VIDEO (Rear Panel)		External Video input or External Video Marker input, switched by pin 1 of the J104 ACCESSORY connector.
Video Input Level		0 to +4V
Marker Input Level		0 to -10V Interfaces with TEKTRONIX 1405 Sideband Adapter.
J104 ACCESSORY (Rear Panel)		25-pin connector (Not RS-232 compatible) Provides bi-directional access to the instrument bus. Also provides external Video select and external preselector drive. All lines are TTL compatible. Maximum voltage on all lines is $\pm 15V$.
Pin 1		External Video Select Low selects External Video Input. High (default) selects Video Marker Input.
Pin 2		Not used
Pin 3		Not used
Pin 4		Internal Control. High (default) selects internal control. Low selects External control.
Pin 5		Chassis Ground
Pins 6-13 ^a		Instrument Bus Address lines 7-0 ^a
Pin 14 ^a		Instrument Bus Data Valid signal ^a
Pin 15 ^a		Instrument Bus Service Request signal ^a
Pin 16 ^a		Instrument Bus Poll signal ^a
Pin 17		Data Bus Enable input signal for external controller. High (unasserted) disables external data bus. Low enables external data bus.
Pins 18-25		Instrument Bus Data lines 0-7 Active when external Data Bus Enable (pin 17) is low.

^aOutput when internally controlled (pin 4 high) and input when externally controlled (pin 4 low).

Table 2-4
OUTPUT SIGNAL CHARACTERISTICS

Characteristic	Performance Requirement	Supplemental Information
Calibrator (CAL OUT)	-20 DBM \pm 0.3 DB at 100 MHz \pm 10 PPM	100 MHz comb of markers provide amplitude calibration at 100 MHz. The frequency tolerance is \pm 15 PPM over the operating temperature range. See the Option Section for alternate specifications.
1st LO and 2nd LO OUTPUTs		Provide access to the output of the respective local oscillators. THESE PORTS MUST BE TERMINATED IN 50 Ω AT ALL TIMES.
1st LO OUTPUT Power		+6 dBm to +15 dBm
2nd LO OUTPUT Power		-10 dBm to +15 dBm.
VERT (OUTPUT) (Rear Panel)		Provides 0.5V \pm 5% of signal per division of video that is above and below the centerline. Source impedance is approximately 1k Ω .
HORIZ (OUTPUT) (Rear Panel)		Provides 0.5V/Div either side of center. Full range -2.5V to +2.5V. Source impedance is approximately 1k Ω .
PEN LIFT (Rear Panel)		TTL compatible, nominal +5V to lift plotter pen.
10 MHz IF (OUTPUT) (Rear Panel)		Provides access to the 10 MHz IF signal. Output level is approximately -5 dBm for a full screen signal at -30 dBm reference level. Nominal impedance is approximately 50 Ω .
IEEE STD 488 PORT (Rear Panel)		In accordance with IEEE 488-1978 standard and Tektronix GPIB Codes, Formats, Conventions, and Features standard
Manual version		Implemented as SH1, AH0, T3, L0, SR0, RL0, PP0, DC0, DT0, and C0
Programmable (P) version		Implemented as SH1, AH1, T5, L3, SR1, RL1, PP1, DC1, DT1, and C0. See Programmers Manual for additional information.
PROBE POWER (Rear Panel)		Provides operating voltages for active probes.
Outputs		
Pin 1		+5V at 100 mA maximum
Pin 2		Ground
Pin 3		-15V at 100 mA maximum
Pin 4		+15V at 100 mA maximum
J104 ACCESSORY (Rear Panel)		All inputs and outputs are listed in Table 2-3 INPUT CHARACTERISTICS.

**Table 2-5
GENERAL CHARACTERISTICS**

Characteristic	Performance Requirement	Supplemental Information
Sweep		Triggered, auto, manual, single sweep, and external
Sweep Time	20 μ s/div–5 s/div in 1-2-5 sequence (10 s/Div available in AUTO)	
Accuracy	$\pm 5\%$ over center 8 divisions	
Triggering		INTernal, EXTernal, FREE RUN, and SINGLE SWEEP
Internal Trigger Level	≥ 2 divisions of signal	
External Trigger Input Level	1.0V peak, minimum	EXTernal is ac-coupled (15 Hz–1 MHz). Maximum external trigger input is 50V (dc + peak ac).
Crt Readout		Displays all parameters listed on the crt bezel, plus help and operating messages.
Battery-Powered Memory		Instrument settings, displays, calibration offsets, and peaking codes for each band are stored in battery-powered RAM.
Battery Life		(See Option 39 in the Options section for alternate specification)
At +55°C Ambient Temperature		1–2 years
At +25°C Ambient Temperature		At least 5 years
Temperature Range for Retaining Data		
Operating		–15°C to +55°C
Non-Operating		–30°C to +85°C

**Table 2-6
POWER REQUIREMENTS**

Characteristic	Performance Requirement	Supplemental Information
Line Frequency Range	48–440 Hz	
Line Voltage Range	90 V _{ac} to 132 V _{ac}	115 V nominal
	180 V _{ac} to 250 V _{ac}	230 V nominal
Line Fuse		
115V Nominal	4A Slow-Blow	
230V Nominal	2A Slow-Blow	
Input Power	210 W maximum (3.2A)	At 115V and 60 Hz
Leakage Current		5 mA maximum

**Table 2-7
ENVIRONMENTAL CHARACTERISTICS**

Meets MIL T-28800C, type III class 3, style C specifications.		
Characteristic	Description	
Temperature		
Operating	-15°C to +55°C	
Non-operating ^a	-62°C to +85°C	
Humidity		
Operating	95% (+5%, -0%) relative humidity	
Non-operating	Five cycles (120 hours) in accordance with MIL-Std-810D procedure 3 (modified)	
Altitude		
Operating	15,000 feet (tested to 25,000 feet)	
Non-operating	40,000 feet (tested to 50,000 feet)	
Vibration, Operating (instrument secured to a vibration platform during test)	MIL-Std-810D, Method 514 Procedure I (modified). Resonant searches in all three axes from 5-15 Hz at 0.060" displacement for 7 minutes, 15-25 Hz at 0.040" displacement for 3 minutes, and 25-55 Hz at 0.020" displacement for 5 minutes (tested to 0.025"). Dwell for an additional 10 minutes in each axis at the frequency of the major resonance or at 55 Hz if none was found. Resonance is defined as twice the input displacement. Total vibration time is 75 minutes.	
Shock (Operating and Non-operating)	Three guillotine-type shocks of 30g, one-half sine, 11 ms duration each direction along each major axis; total of 18 shocks. (Tested to 50g.)	
Transit drop (free fall)	8 inch, one per each of six faces and eight corners (instrument is tested and meets drop height of 12 inches).	
Electromagnetic Interference (EMI)	Meets requirements described in MIL-Std-461B Part 4, except as noted.	
	Test Method	Remarks
Conducted Emissions	CE01—60 Hz to 15 kHz	1 kHz to 15 kHz only
	CE03—15 kHz to 50 MHz power leads	15 kHz to 50 kHz, relaxed by 15 dB
Conducted Susceptibility	CS01—30 Hz to 50 kHz power leads	Full limits
	CS02—50 kHz to 400 MHz power leads	Full limits
	CS06—spike power leads	Full limits
Radiated Emissions	RE01—30 Hz to 50 kHz magnetic field	Relaxed by 10 dB for fundamental to 10th harmonic of power line. Exceptioned, 30 kHz to 36 kHz
	RE02—14 kHz to 10 GHz	Full limit

^aAfter storage at temperatures below -15°C, the instrument may not reset when power is first turned on. If this happens, allow the instrument to warm up for at least 15 minutes, then turn POWER OFF for 5 seconds and back ON.

Table 2-7 (Continued)
ENVIRONMENTAL CHARACTERISTICS

Characteristic	Description	
Electromagnetic Interference (EMI) (continued)		
Radiated Susceptibility	Test Method	Remarks
	RS01—30 kHz to 50 kHz	Full limit
	RS02—Magnetic Induction	To 5A only
	RS03—14 kHz to 10 GHz	Up to 1 GHz

Table 2-8
PHYSICAL CHARACTERISTICS

Characteristic	Description
Weight	41 lbs 15 oz. (19.1 kg) maximum (see Options 01, 07, 30, and 31 in the Options section for alternate specification) Including cover and standard accessories, except manuals.
Dimensions (See Figure 2-1)	
Without Front Cover, Handle, or Feet	6.9 × 12.87 × 19.65 inches (175 × 327 × 499 mm)
With Front Cover, Feet, and Handle Handle Folded Back Over the Instrument	9.15 × 15.05 × 23.1 inches (232 × 382 × 587 mm)
Handle Fully Extended	9.15 × 15.05 × 28.85 inches (232 × 382 × 732.8 mm)

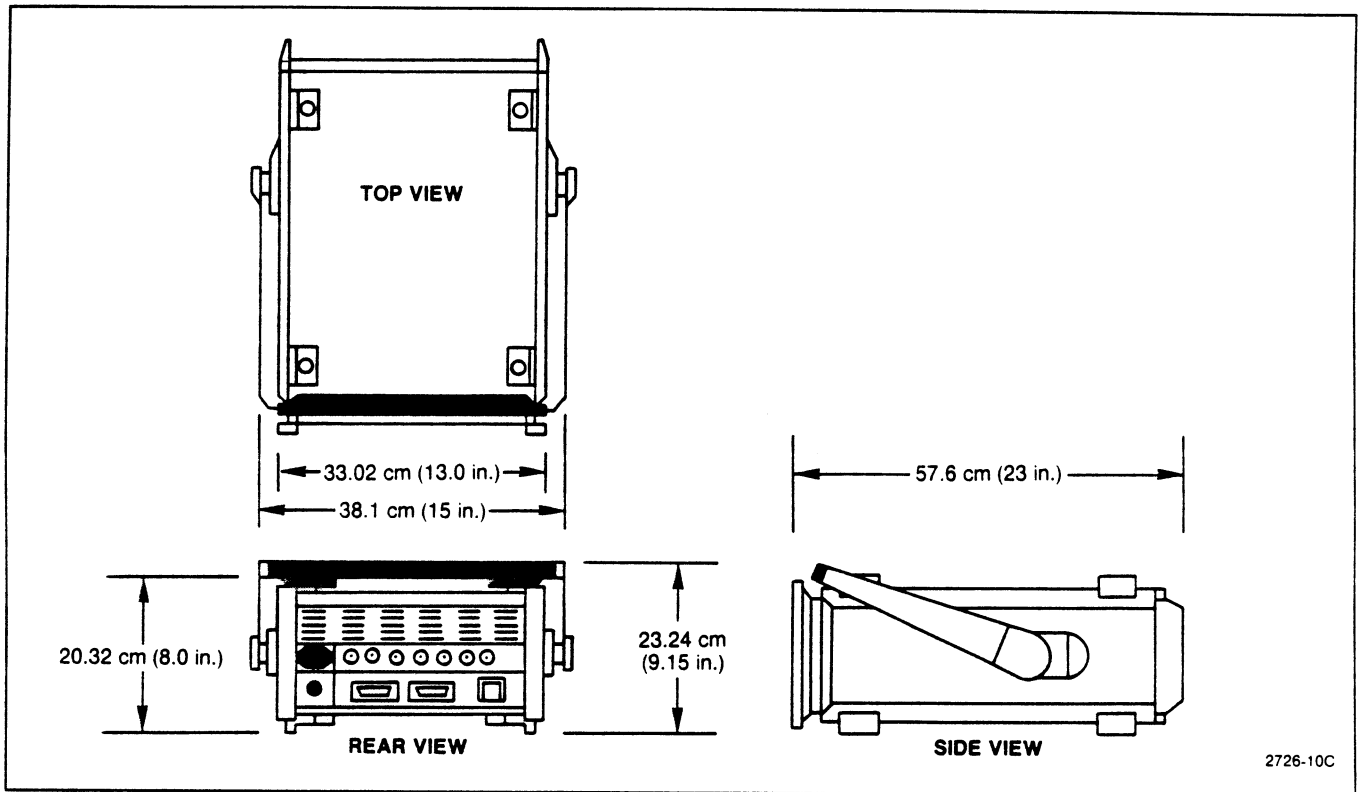

Figure 2-1. Dimensions.

PREPARATION FOR USE

This section describes spectrum analyzer unpacking, installation, power requirements, storage information, and repackaging.

UNPACKING AND INITIAL INSPECTION

Before unpacking the spectrum analyzer, inspect the shipping container for signs of external damage. If the container is damaged, notify the carrier as well as Tektronix, Inc. The shipping container contains the basic instrument and its standard accessories. For a list of the standard accessories, refer to Standard Accessories, in Section 1 of this Manual (or, for ordering information, refer to the list following the Replaceable Mechanical Parts list in the Service Manual, Volume 2).

If the contents of the shipping container are incomplete, if there is mechanical damage or defect, or if the instrument does not meet operational check requirements, contact your local Tektronix Field Office or representative.

Keep the shipping container if the instrument is to be stored or shipped to Tektronix for service or repair. Refer to Storage and Repackaging for Shipment later in this section.

The instrument was inspected both mechanically and electrically before shipment, and it should be free of mechanical damage and meet or exceed all electrical specifications. The Operation section of this Manual contains procedures to check functional or operational performance. Perform the functional check procedure to verify that the instrument is operating properly. This check is intended to satisfy the requirements for most receiving or incoming inspections. (A detailed electrical performance verification procedure in the Service Manual, Volume 1, provides a check of all specified performance requirements, as listed in the Specification section.)

The instrument can be operated in any position that allows air flow in the bottom and out the rear of the instrument. Feet on the four corners allow ample clearance even if the instrument is stacked with other instruments. The air is drawn in by a fan through the bottom and expelled out the back. Avoid locating the instrument where paper, plastic, or any other material might block the air intake.

INSTALLATION

The front cover provides a dust-tight seal and a convenient place to store accessories and external waveguide mixers. Use the cover to protect the front panel when storing or transporting the instrument. To remove the cover, stand the instrument on the two back feet so the name on the handle is facing up and towards you, and pull slightly out and up on the sides of the cover. Attached to the inside of the cover is the accessories pouch. To open the accessories pouch, pull up evenly on the flap.

You can position the handle of the spectrum analyzer at several angles to serve as a tilt stand. To stack instruments, position the handle at the top rear of the instrument. To change the handle position, press in at both pivot points and rotate the handle to the desired position.

WARNING

Removing or replacing the cabinet on the instrument can be hazardous. Only qualified service personnel should attempt to remove the instrument cabinet.

Rackmount Instrument

Refer to the Service Manual, Volume 1, for installation instructions for the rackmount version of the instrument. Refer installation to qualified service personnel.

CAUTION

If the rackmount instrument is extended out of the rack and tipped up to gain access to the bottom or back panels of the cabinet, securely hold the instrument so it cannot fall back into the rack. Use care when doing this to avoid damaging the instrument front panel or equipment that may be mounted above the instrument.

Rack Adapter Kit

A field-installable kit is available to permit the spectrum analyzer to be rack mounted in a standard 19-inch-wide rack on a non-tilting slide-out track. We recommend fan-forced ventilation of the rack enclosure. If the rack-adapter assembly is installed in an enclosed rack, a minimum depth of 25 inches behind the front panel is recommended for proper air circulation. The rack adapter kit comes complete with the slide-out tracks and all necessary mounting hardware. Contact your local Tektronix Field Office or representative for additional information and ordering instructions.

POWER SOURCE AND POWER REQUIREMENTS

The spectrum analyzer is intended to be operated from a single-phase power source that has one of its current-carrying conductors (neutral) at ground (earth) potential. It is not recommended to operate the spectrum analyzer from power sources where both current-carrying conductors are isolated or above ground potential (such as phase-to-phase on a multi-phase system or across the legs of a 110-220 V single-phase, three-wire system). In this method of operation, only the line conductor has over-current (fuse) protection within the unit. Refer to the Safety Summary at the front of this Manual.

The ac power connector is a three-wire, polarized plug with the ground (earth) lead connected directly to the instrument frame to provide electrical shock protection. If the unit is connected to any other power source, connect the unit frame to an earth ground.

Operate the spectrum analyzer from either 115 Vac or 230 Vac nominal line voltage with a range of 90 to 132 or 180 to 250 Vac, at 48 to 440 Hz. Power and voltage requirements are printed on a back-panel plate mounted below the power input jack. Refer power input changes to qualified service personnel. The Service Manual, Volume 1, contains instructions to change the input voltage range.

The international power cord and plug configuration is shown in Figure 7-1 in Section 7 of this Manual.

WARNING

Do not attempt to change the power input requirements. Unfamiliarity with safety procedures can result in personal injury. Refer all power input changes to qualified service personnel. Refer to the Safety Summary at the front of this Manual.

STORAGE AND REPACKAGING

Storage

Short Term (less than 90 days) — For short term storage, store the instrument in an environment that meets the non-operating environmental specifications in Table 2-7 in Section 2 of this Manual.

Long Term — For instrument storage of more than 90 days, use the original shipping container to repackage the instrument. (In Option 39 instruments, we recommend removing the silver batteries during long-term storage.) Package the instrument in a vapor bag with a drying material and store in a location that meets the non-operating environmental specifications in Table 2-7 in Section 2 of this Manual.

If you have any questions, contact your local Tektronix Field Office or representative.

Repackaging for Shipment

When the spectrum analyzer is to be shipped to a Tektronix Service Center for service or repair, attach a tag that shows the owner and address, the name of the individual at your location that can be contacted, the complete instrument serial number (stamped on the lower portion of the instrument front panel), and a description of the service required. If the original shipping container is unfit for use or not available, use the following repackaging information.

1. Use a container of corrugated cardboard with a test strength of 375 pounds (140 kilograms) and inside dimensions that are at least six inches more than the equipment dimensions (refer to Table 2-8 in Section 2), to allow for cushioning.

2. Install the instrument front cover, and surround the instrument with plastic sheeting to protect the finish.

3. Cushion the equipment on all sides with packing material or plastic foam.

4. Seal the container with shipping tape or an industrial, heavy-duty stapler.

Transit Case

A high-impact, ruggedized transit case is recommended if you require your spectrum analyzer to be frequently shipped between sites. A hard transit case that meets these requirements and has space to hold most of the instrument's standard accessories is provided as an optional accessory for the spectrum analyzer. The ordering number for this hard transit case is in the Optional

Accessories information in the Service Manual, Volume 2. Refer to your local Tektronix Field Office or representative for additional information. The hard transit case is not available for rackmount (Options 30 and 31) instruments.

*This Document is a complete Scan from the original
Tektronix manual
For enquiries about our complete
High quality line of technical Manuals in PDF
mailto : Qservice@otenet.gr*

**SEE
OTHER
SIDE**

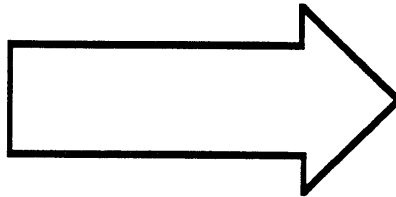

CONTROLS, CONNECTORS, AND INDICATORS

This section includes the descriptions of the instrument's main operating modes. It also covers the functions of the controls, selectors, indicators, all connectors for the spectrum analyzer, which are shown and identified in Figures 4-1 through 4-3 and 4-11 through 4-16. Some of the functions are described in greater detail in Section 5.

Included with many of the descriptions are syntax diagrams that graphically display the function. The ovals and circles indicate a literal element that must be sent (i.e., pushbutton pressed) exactly as shown. Boxes contain a name for an element (i.e., DATA ENTRY represents numbered pushbuttons 0 through 9, units terminators, ".", and BACKSPACE). The arrows that connect the elements of the syntax diagrams show the possible paths through the diagram. Parallel paths mean that one, and only one, of the paths must be followed. A path around an element or group of elements indicates an optional skip. Arrows indicate the direction that must be followed (usually the flow is to the right; but, if an element may be repeated, an arrow returns from the right to the left of the element).

The following examples illustrate basic syntax diagram structure.

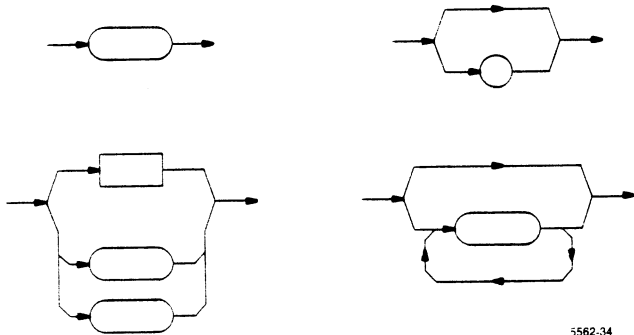

5562-34

When DATA ENTRY boxes are part of a command's syntax diagram, there are numbers shown with the boxes. These numbers represent the valid range available for that particular command.

OPERATING MODES

Initial Entry Functions (Black-Labels)

Most of the spectrum analyzer operating modes are selected by a single pushbutton press or control turn; i.e., FREE RUN, TIME/DIV, PULSE STRETCHER, MAX HOLD, PEAK/AVERAGE. Generally, these selections are the same with all Tektronix 49x-Series Spectrum Analyzers.

Multiple-Pushbutton Sequence Functions (SHIFT Pushbuttons)

<Blue-SHIFT> Functions — There are many general operating modes and two marker operating modes selected with multiple-pushbutton presses. Press the <blue-SHIFT> pushbutton before selecting a blue-labeled function; i.e., PLOT, STORE DISP, CAL. For many of these functions, menu prompts appear on the screen to guide you.

<Green-SHIFT> Functions — Most of the operating modes selected with green-SHIFT multiple-pushbutton presses are marker related. Press the <green-SHIFT> pushbutton before selecting a green-labeled function; i.e., ASSIGN 1, PEAK FIND. For many of these functions, menu prompts appear on the crt readout to guide you.

There are also additional marker functions that can be assigned to either pushbutton ASSIGN 1 or ASSIGN 2 and then selected in the same manner as the labeled functions. MARKER MENU also has additional marker functions that can be selected directly from the menu.

Terminating Multiple-Pushbutton Sequences

A SHIFT multiple-pushbutton sequence can be terminated at any time. Push either the <blue-SHIFT> or <green-SHIFT> pushbutton once to stop the sequence and return the spectrum analyzer to the previous activity.

DATA ENTRY Functions (Orange Labels)

Some operations require the entry of numerical data; for example, to set frequency or enter a number to select a choice from a menu. This will be as part of a multiple-pushbutton sequence, and the crt will prompt you when a number is required. Enter the number with the orange-labeled DATA ENTRY pushbuttons. Numerical data is entered first, with a units terminator entered last; e.g., 100.00 MHz or 20 -dBx.

Correcting Numerical Entry Errors

Use the BACKSPACE pushbutton to correct errors in numerical data that have been entered with the orange-labeled DATA ENTRY pushbuttons. Each pushbutton press backs the cursor up one space, erasing the number in that location. You can then enter the correct numerical data and end the sequence with a units pushbutton.

INSTRUMENT POWER CONTROL AND FREQUENCY

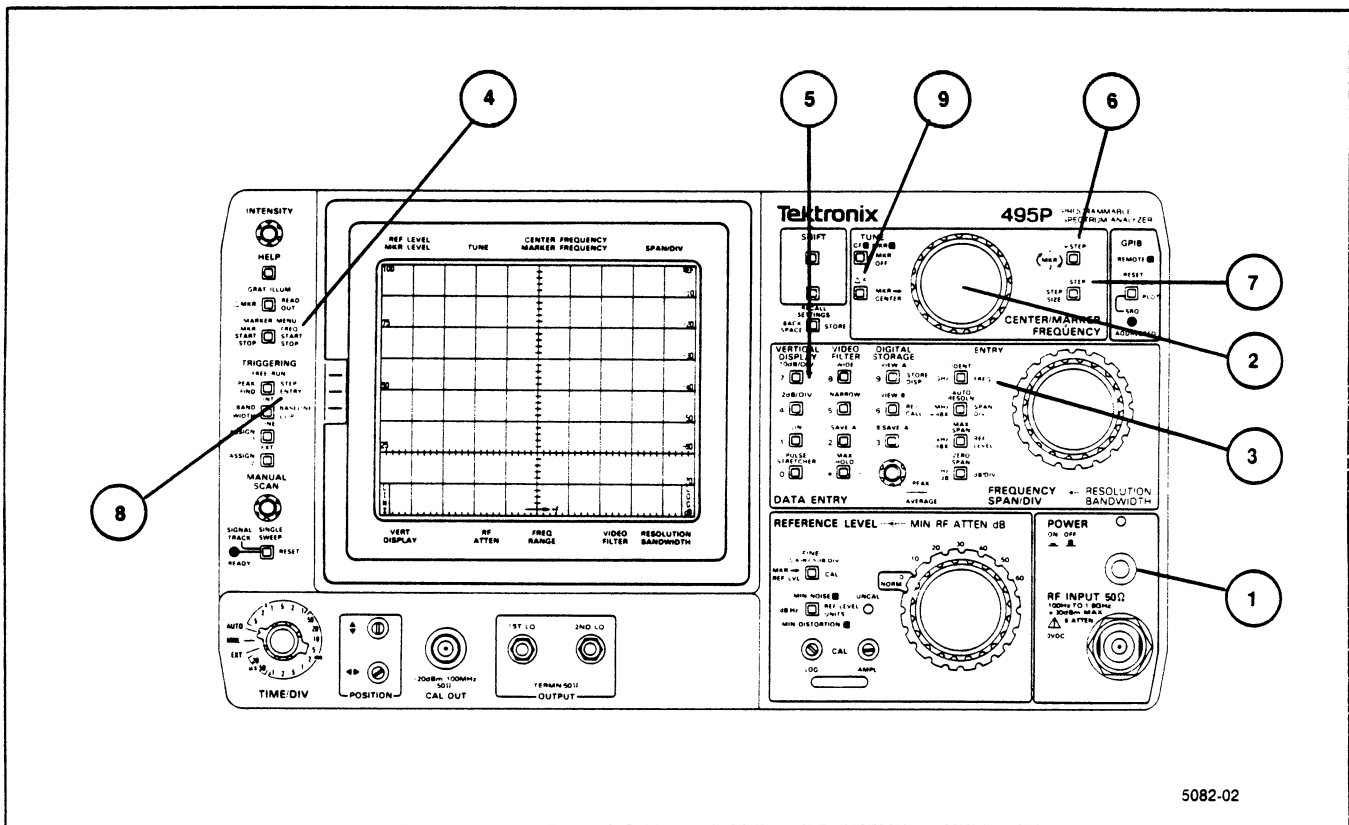
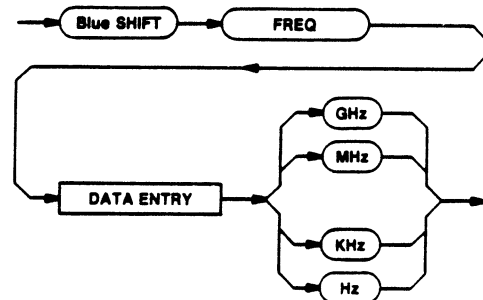

Figure 4-1

- 1 **POWER** — This push-push switch turns the main power supply ON (green light on) and OFF (in=ON, out=OFF). When power is switched off, the current instrument front-panel set-up is stored in memory register 0 (see RECALL SETTINGS/STORE in Section 5) so this set-up can be easily recalled. Full RF attenuation is switched in when power is switched off to protect the 1st mixer from overload and damage.
- 2 **CENTER/MARKER FREQUENCY** — This control tunes the center frequency or marker, if selected. Tuning of center frequency is done in 0.1 division increments, regardless of the selected FREQUENCY SPAN/DIV. For marker frequency, tuning is either 0.01, 0.033, or 0.1 division increments, depending on how fast the control is turned. In MAX SPAN, the center frequency is fixed, and only the frequency dot is tuned. The tuning range in narrow spans is identical to wide spans.
- 3 **<Blue-SHIFT> FREQ** — This pushbutton sequence allows direct entry of center or marker frequency to 1 Hz resolution (it will be displayed to 100 Hz), from the DATA ENTRY pushbuttons. If the center frequency entered is not in the current frequency range, the nearest frequency range that contains the frequency will be automatically selected. The center frequency range that can be selected is 0 Hz to 1800 MHz. Values that are entered outside this range will be ignored. Frequency digits that are entered from the DATA ENTRY pushbuttons are terminated with one of the four unit pushbuttons (GHz, MHz, kHz, or Hz).



5082-13

- 4 **<Blue-SHIFT> FREQ START STOP** — This pushbutton sequence allows you to use the orange DATA ENTRY pushbuttons to enter a start frequency (at the left edge of the display) and a stop frequency (at the right edge of the display).
- 5 **<Blue-SHIFT> 10dB/DIV (Disable Frequency Corrections; not identified on the front panel)** — This pushbutton sequence disables the frequency correction for the local oscillators. This enables the instrument to be operated with reduced performance if the oscillator frequency cannot be corrected.
- 6 **+STEP** — When the instrument is in the Tune Center Frequency mode (TUNE CF/MKR pushbutton unlit), this pushbutton increases the center frequency by steps. The step size is determined by <blue-SHIFT> STEP ENTRY or <green-SHIFT> STEP SIZE. See +STEP later in this section under Marker Functions for alternate operation.
- 7 **-STEP** — When the instrument is in the Tune Center Frequency mode (TUNE CF/MKR pushbutton unlit), this pushbutton decreases the center frequency by steps. The step size is determined by <blue-SHIFT> STEP ENTRY or <green-SHIFT> STEP SIZE. See -STEP later in this section under Marker Functions for alternate operation.
- 8 **<Blue-SHIFT> STEP ENTRY** — This pushbutton sequence allows you to enter a desired center or marker frequency step size with the orange DATA ENTRY pushbuttons.
- 9 **ΔF** — This pushbutton allows measurement of the frequency differences. When pressed (lit), the frequency readout goes to zero. The readout now shows only the offset, or deviation, from this reference as the center frequency is changed. The resolution of the readout will be the less accurate of either the current center frequency resolution or the center frequency resolution when ΔF was activated. Do not confuse this pushbutton with <green-SHIFT> Δ MKR, which is described later in this section under Marker Functions.

FREQUENCY SPAN AND RESOLUTION

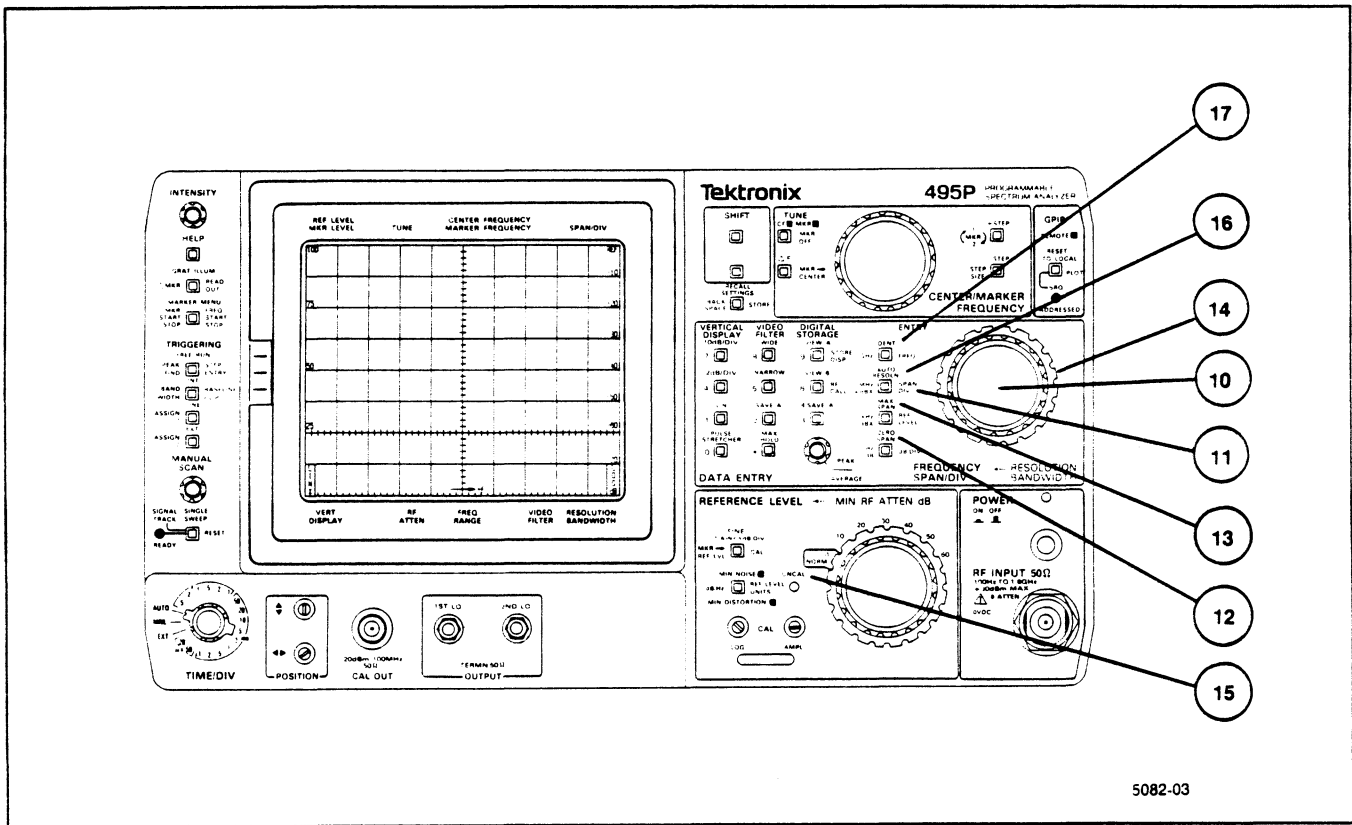

Figure 4-2

10 **FREQUENCY SPAN/DIV** — This control selects the frequency span swept by the spectrum analyzer. The range of this control is 50 Hz/div to 100 MHz/div. The span/div is indicated by the CRT readout. Selection is in a 1-2-5 sequence plus max span and zero, or time domain. **FREQUENCY SPAN/DIV** can also be entered with the <blue-SHIFT> SPAN/DIV pushbutton sequence and the **DATA ENTRY** pushbuttons. The spectrum analyzer will try to maintain a calibrated display if the **TIME/DIV** control is in the **AUTO** position or the **AUTO RESOLN** pushbutton is active (lit).

When the **FREQUENCY SPAN/DIV** is in the maximum span mode, the full band is displayed. A dot near the top of the screen indicates the center frequency readout position on the span. This dot and the center frequency position will be center screen when the **FREQUENCY SPAN/DIV** is reduced from the **MAX** span position. When the markers are on, they show the frequency position, and the dot goes to center.

When the **FREQUENCY SPAN/DIV** is reduced to zero, the spectrum analyzer operates like a tunable receiver. The spectrum analyzer displays signals within the resolution bandwidth in the time domain, with the CRT reading out time/div instead of frequency span/div.

- 11 **<Blue-SHIFT> SPAN/DIV** — This pushbutton sequence allows direct entry of FREQUENCY SPAN/DIV, with two significant digits of resolution. The span/div range that can be selected is 50 Hz/div to 170 MHz/div. If a value outside the allowable range is entered, the Span/Div will switch to 50 Hz if the selected value is less than 50 Hz, or maximum span if the selected value is greater than 170 Hz. Spans entered from the DATA ENTRY pushbuttons are terminated with one of the four unit pushbuttons (GHz, MHz, kHz, or Hz).

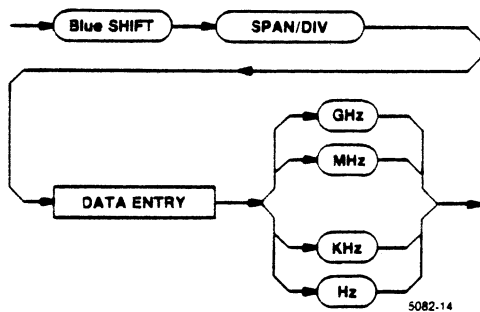

- 12 **ZERO SPAN** — This pushbutton switches the span to zero for time domain display. When deactivated, the Span/Div returns to its previous value.
- 13 **MAX SPAN** — When activated, the spectrum analyzer sweeps the entire frequency range. The position of the spectrum analyzer's center frequency is shown with a dot near the top of the screen. When this function is turned off, the span returns to the previous Frequency Span/Div setting. When the markers are on, they show the frequency position, and the dot goes to center.

- 14 **RESOLUTION BANDWIDTH** — This control selects the bandwidth of the spectrum analyzer. Selected bandwidth is indicated on the crt readout. The bandwidth selections are 30 Hz, 100 Hz, 1 kHz, 10 kHz, 100 kHz, and 1 MHz. Time/div is automatically selected to match the selected bandwidth when the TIME/DIV control is in the AUTO position.
- 15 **UNCAL** — This indicator lights when the display amplitude or frequency is no longer calibrated; e.g., the sweep rate is not compatible with the frequency span/div and resolution bandwidth. Select a slower sweep rate or larger resolution bandwidth to return to calibrated operation.
- 16 **AUTO RESOLN** — When this function is on, resolution bandwidth is automatically selected to maintain a calibrated display for, if possible, the selected Freq Span/Div, Time/Div, Video Filter, and Vertical Display modes. When the TIME/DIV control is in the AUTO position, resolution bandwidth is selected as a function of Freq Span/Div only, and Time/Div is selected to maintain a calibrated display at the highest sweep rate. The RESOLUTION BANDWIDTH control will not operate when AUTO RESOLN is on (the message TO CHANGE RESOLUTION AUTO RESOLN MUST BE OFF will appear on the screen).
- 17 **IDENT** — IDENT allows identification of unwanted, internally-generated mixing products, as is generally the case when power at the input exceeds the reference level by >30 dB. This pushbutton causes every other trace to be displaced vertically. The 1st and 2nd local oscillator frequencies shift so that real, or true, signals are not displaced horizontally on alternate sweeps, while spurious signals can be shifted. The FREQ SPAN/DIV must be 50 kHz or less.

MARKER FUNCTIONS

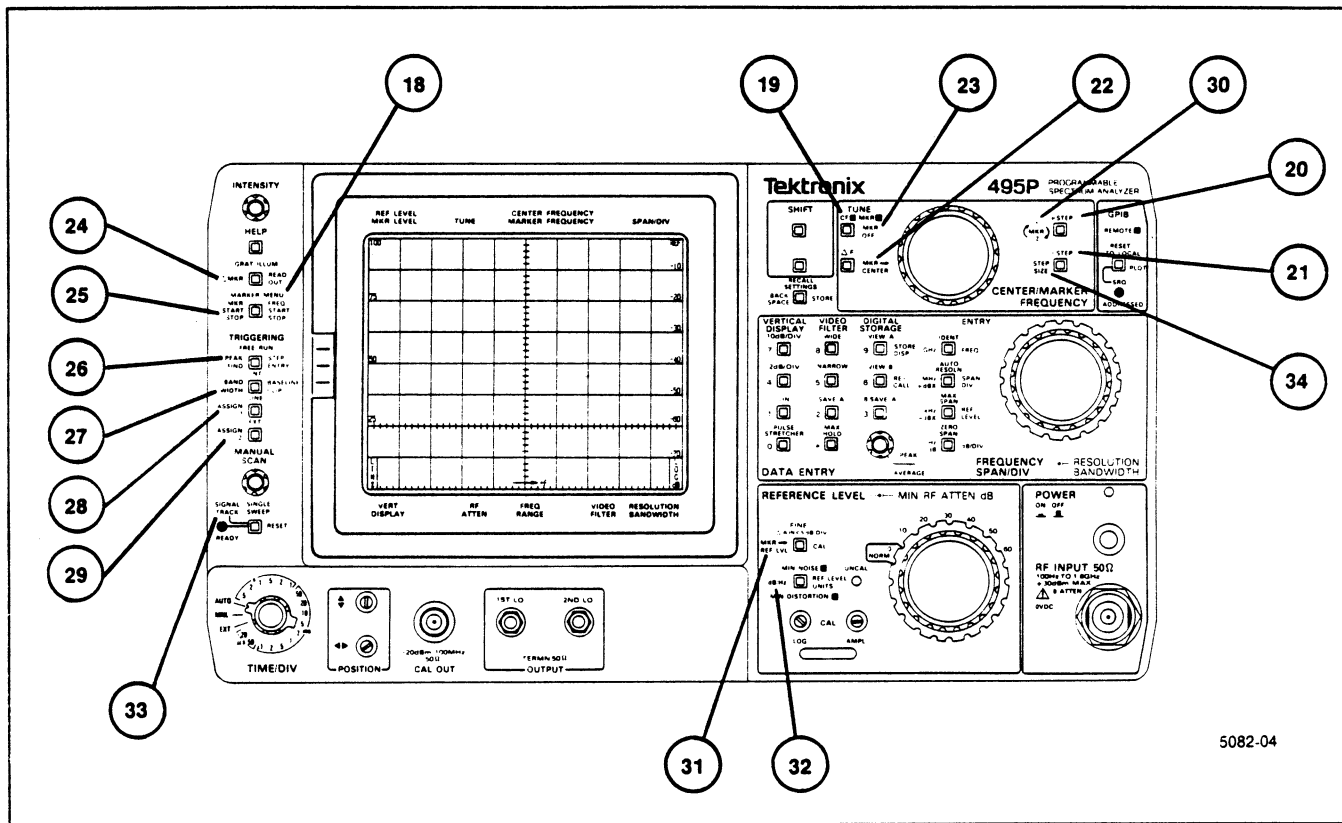

Figure 4-3

18 MARKER MENU — This pushbutton calls up a menu display on the crt that allows selection of one of the available marker commands that are not permanently assigned to a front-panel pushbutton.

RIGHT NEXT — This moves the Primary marker to the next visible signal higher than the present marker frequency. If there is no signal to the right of the Primary marker that meets threshold and signal type parameters, one of the following messages will be displayed on the screen (depending on whether CW, PULSE, or SPURS has been selected as the signal type) —

NO CW TO THE RIGHT ABOVE THRESHOLD

NO PULSE TO THE RIGHT ABOVE THRESHOLD

NO SPUR TO THE RIGHT ABOVE THRESHOLD

Select SET SIGNAL THRESHOLD and SET SIGNAL TYPE from the Marker Menu to set the parameters.

LEFT NEXT — This moves the Primary marker to the next visible signal lower than the present marker frequency. If there is no signal to the left of the Primary marker that meets threshold and signal type parameters, one of the following messages will be displayed on the screen (depending on whether CW, PULSE, or SPURS has been selected as the signal type) —

NO CW TO THE LEFT ABOVE THRESHOLD

NO PULSE TO THE LEFT ABOVE THRESHOLD

NO SPUR TO THE LEFT ABOVE THRESHOLD

5082-04

Select SET SIGNAL THRESHOLD and SET SIGNAL TYPE from the MARKER MENU to set the parameters.

NEXT LOWER PEAK — This moves the Primary marker to the signal with the next lower amplitude, either left or right of the present marker position. If there is no signal lower than the Primary marker that meets threshold and signal type parameters, one of the following messages will be displayed on the screen (depending on whether CW, PULSE, or SPURS has been selected as the signal type) —

NO LOWER CW SIGNAL ABOVE THRESHOLD

NO LOWER PULSE SIGNAL ABOVE THRESHOLD

NO LOWER SPUR ABOVE THRESHOLD

Select SET SIGNAL THRESHOLD and SET SIGNAL TYPE from the MARKER MENU to set the parameters.

NEXT HIGHER PEAK — This moves the Primary marker to the signal with the next higher amplitude, either left or right of the present marker position. If there is no signal higher than the Primary marker that meets threshold and signal type parameters, one of the following messages will be displayed on the screen (depending on whether CW, PULSE, or SPURS has been selected as the signal type) —

NO HIGHER CW SIGNAL ABOVE THRESHOLD

NO HIGHER PULSE SIGNAL ABOVE THRESHOLD

NO HIGHER SPUR ABOVE THRESHOLD

Select SET SIGNAL THRESHOLD and SET SIGNAL TYPE from the MARKER MENU to set the parameters.

SET SIGNAL TYPE — This alters the marker functions to recognize one of three signal types above the threshold (select SET SIGNAL THRESHOLD from the MARKER MENU to set the threshold).

CW — Identifies continuous wave signals and ignores spurious signals and impulses.

PULSE — Identifies the peak of pulsed RF lobes for either line (lines must be <2 minor divisions apart) or dense spectra.

SPURS — Identifies all signals.

Figure 4-4 is a signal enlarged to show how the spectrum analyzer locates the signal peak with one of the signal processing functions. The signal processing functions are RIGHT NEXT, LEFT NEXT, NEXT LOWER PEAK, NEXT HIGHER PEAK. The spectrum analyzer looks at both the individual left-most and right-most peaks of a signal. From this reading, the spectrum analyzer calculates the exact center of the signal. If this location is a digital storage point, the marker is positioned here. If, as in Figure 4-4, the calculated center of the signal is not equal to the maximum digital storage point, the marker is positioned on the closest point to the center. At the end of this Marker Functions portion are five illustrations showing the use of this signal finding command.

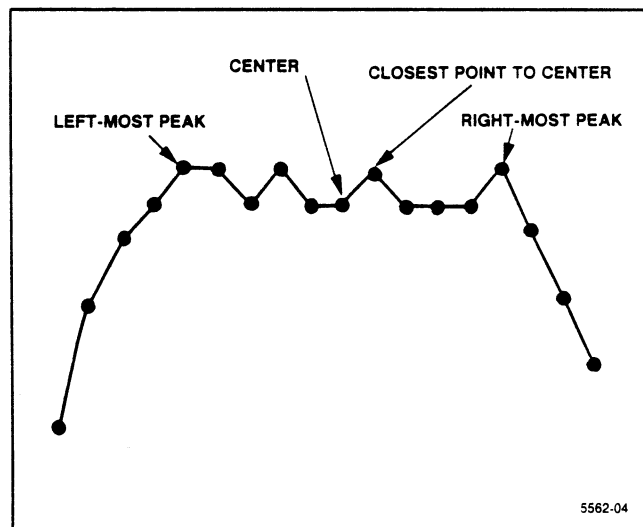

Figure 4-4. Locating the signal peak.

SET SIGNAL THRESHOLD — This changes the minimum visible signal level for the marker functions of Right Next, Left Next, Next Lower Peak, Next Higher Peak, Peak Find, Bandwidth Mode, and Signal Track. Select AUTO to automatically set the threshold above the noise floor.

ASSIGN FUNCTION TO KEY — This displays a menu (Assign Menu) of additional marker functions that can be assigned to either the <green-SHIFT> ASSIGN 1 or <green-SHIFT> ASSIGN 2 pushbutton. Call up HELP for the assigned pushbutton to get a description of the assigned function. The function will remain assigned to the pushbutton, even with power

off, until another function is assigned. The ASSIGN MENU accesses the following functions as well as RIGHT NEXT, LEFT NEXT, NEXT LOWER PEAK, and NEXT HIGHER PEAK, which are described under MARKER MENU.

MOVE RIGHT X dB — This allows you to select the number of dB to move the Primary marker while staying on the trace (horizontal movement to the right). If there is no level to the right of the Primary marker that meets threshold, the message NO POINT TO THE RIGHT TO MOVE TO will be displayed on the screen.

MOVE LEFT X dB — This allows you to select the number of dB to move the Primary marker while staying on the trace (horizontal movement to the left). If there is no level to the left of the Primary marker that meets threshold, the message NO POINT TO THE LEFT TO MOVE TO will be displayed on the screen.

FIND PEAK AND CENTER — This places the active marker at the peak of the highest on-screen signal (refer to the <green-SHIFT> PEAK FIND description later in this section). If a signal is present, the center frequency is set equal to the marker frequency; this centers the signal of interest (this is useful when reducing span/div by several settings at once). If there is no signal above the threshold, the message NO POINT FOUND ABOVE THE THRESHOLD will be displayed on the screen, and the marker will not move.

ENTER BANDWIDTH NUMBER — This sets the number of dB below the signal peak at which bandwidth will be calculated when in the marker Bandwidth mode. The number is stored in memory.

GREEN-SHIFT LOCK — This locks <green-SHIFT> on so all green-labeled functions can be directly selected. When Green-Shift Lock is on, the black-labeled functions associated with green-labeled functions cannot be accessed. Blue-labeled functions operate normally. Press <green-SHIFT> to exit.

- 19 **TUNE CF/MKR** — When this pushbutton is lit, a single marker appears on the trace of highest priority. The marker can be moved with the CENTER/MARKER FREQUENCY control. When the pushbutton is pressed again, the marker remains and does not change its horizontal position; the CENTER/MARKER FREQUENCY control now adjusts the center frequency.

- 20 **+STEP** — When the instrument is in the tune marker mode (the TUNE CF/MKR pushbutton is lit), this pushbutton increases the marker frequency by steps (this function is limited to the edge of the screen when not on an active trace). The step size is determined by <green-SHIFT> STEP SIZE or <blue-SHIFT> STEP ENTRY. See +STEP earlier in this section under Frequency for alternate operation.

- 21 **-STEP** — When the instrument is in the tune marker mode (the TUNE CF/MKR pushbutton is lit), this pushbutton decreases the marker frequency by steps (this function is limited to the edge of the screen when not on an active trace). The step size is determined by <green-SHIFT> STEP SIZE or <blue-SHIFT> STEP ENTRY. See -STEP earlier in this section under Frequency for alternate operation.

- 22 **<Blue-SHIFT> MKR → CENTER** — This pushbutton sequence centers the signal at the active marker by setting the center frequency equal to the marker frequency (this function is not available with a stored trace).

- 23 **<Blue-SHIFT> MKR OFF** — This pushbutton sequence turns the marker(s) off.

- 24 **<Green-SHIFT> Δ MKR** — This pushbutton sequence is the on-off switch for the Delta Marker mode. When activated, a second marker appears at the position of the single marker on the trace. The symbols () will appear on the screen on the marker frequency readout line to indicate delta frequency and delta amplitude. To use Delta Marker, select TUNE CF/MKR and set the marker to one point of interest on the trace using the CENTER/MARKER FREQUENCY control. Activate the Delta Marker Mode and move one of the markers to the second point of interest. Push Δ MKR again to turn delta markers off.

- 25 **<Green-SHIFT> MKR START STOP** — This pushbutton sequence allows you to set the start and stop frequencies directly from the delta marker position (this function is not available with a stored trace). <Green-SHIFT> Δ MKR must be on for this function to operate.

- 26 **<Green-SHIFT> PEAK FIND** — This pushbutton sequence places the Primary marker at the peak of the highest on-screen signal. <Green-SHIFT> PEAK FIND locates the left-most peak (or the center peak of a cluster), but it is not a signal processing command with the built-in intelligence. Peak B would be selected from the cluster in Figure 4-5A; peak A would be selected in Figure 4-5B because the low point (B) would stop a search from continuing to the cluster (C).

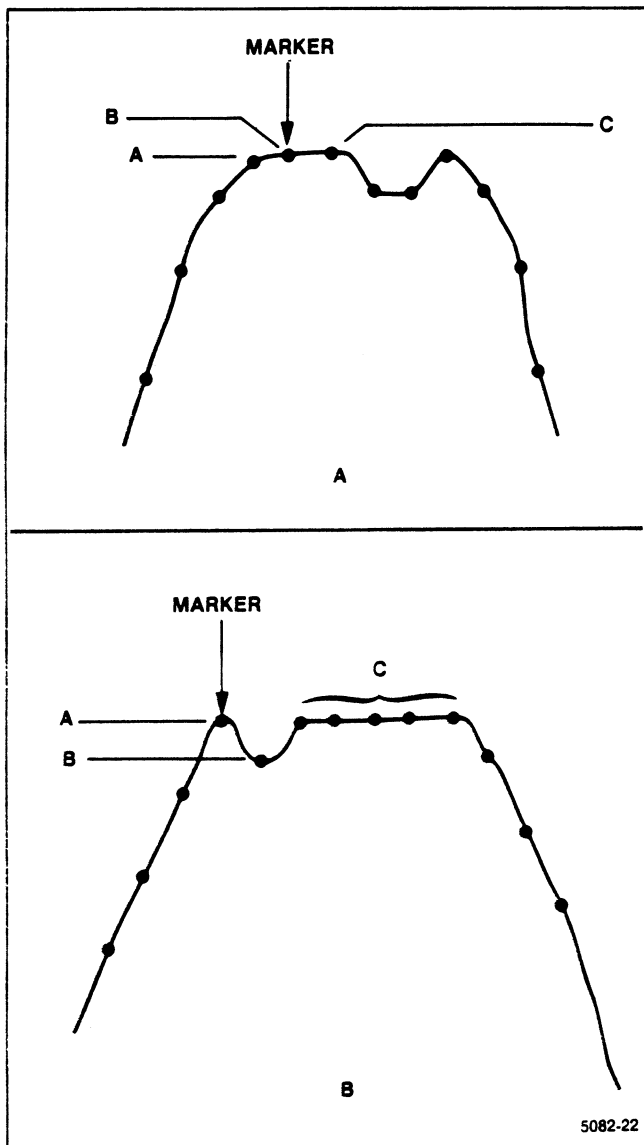

Figure 4-5. Using <green-SHIFT> PEAK FIND.

- 27 <Green-SHIFT> BANDWIDTH — This pushbutton sequence places markers on a selected signal and displays the X dB bandwidth (select ENTER BANDWIDTH NUMBER from the marker menu to set X). The screen will display NO SIGNAL — BW IDLE when there is no signal at the marker that meets threshold and bandwidth parameters. Set the parameters by selecting SET SIGNAL THRESHOLD and ENTER BANDWIDTH NUMBER after calling up the MARKER MENU each time.
- 28 <Green-SHIFT> ASSIGN 1 — This pushbutton sequence turns on the assigned function.
- 29 <Green-SHIFT> ASSIGN 2 — This pushbutton sequence turns on the assigned function.

- 30 <Green-SHIFT> 1—MKR→2 — This pushbutton sequence alternately selects which marker will be tuned when <green-SHIFT> Δ MKR is on.
- 31 <Green-SHIFT> MKR → REF LVL — This pushbutton sequence changes the reference level of the top graticule to the present marker amplitude (this function is not available with a stored trace).
- 32 <Green-SHIFT> dB/Hz — This pushbutton sequence mathematically figures the average noise power in a bandwidth at the current marker position.
- 33 <Green-SHIFT> SIGNAL TRACK — This pushbutton sequence automatically maintains tuning of a drifting signal within limits. While this mode is active SIGNAL TRACK will be displayed on the screen; SIGNAL TRACK IDLE will be displayed when there is no signal above the threshold. Excessive drift will disable this function. Select SET SIGNAL THRESHOLD from the MARKER MENU to set the threshold.
- 34 <Green-SHIFT> STEP SIZE — This pushbutton sequence defines the frequency step as the center frequency, marker frequency, or the delta marker frequency, whichever mode is active.

Signal Finding

To the finding routine, a signal consists of a peak above threshold and two points (one on each side of the peak) that are 3 dB below the peak. The location of the signal is the highest amplitude point on the signal. Figures 4-6 through 4-10 illustrate the use of SET SIGNAL TYPE that can be selected from the MARKER MENU. All of the figures use the signal processing function RIGHT NEXT. Any of the other signal processing functions (LEFT NEXT, NEXT LOWER PEAK, NEXT HIGHER PEAK) work similarly, according to their specific function. The minimum bandwidth criteria for CW is defined as the two 3 dB down points that must be < 5 kHz (1/2 a resolution bandwidth) apart.

Figures 4-6, 4-7, and 4-8 — If CW was selected, the spectrum analyzer would not identify any signal because none of the signals displayed meets the minimum bandwidth criteria. If PULSE was selected, the signals labeled D, E, and F would be identified because the other signals in the display are less than 2 minor divisions apart. If the signals were greater than 2 minor divisions apart, PULSE would have identified all labeled signals (A, B, C, etc.). If SPURS was selected, all signals would be identified (A, B, C, etc.).

Figure 4-9 — The NEXT RIGHT function begins at the left screen margin. With this display, CW, PULSE, and SPURS will each identify all of the signals because they all meet the minimum bandwidth criteria (i.e., the selections would be A, B, C, D, and E).

Figure 4-10 — The threshold is assumed to be -70 dBm. If CW was selected, signals B, E, F, and G would be identified. The other signals would not be identified because they do not meet the minimum bandwidth criteria. If PULSE was selected, signals A, B, D, E, F, and G would be identified. Signal C would be skipped, because it is within 2 minor divisions from signal B. The PULSE algorithm will think signal C is a part of signal B. If SPURS was selected, all signals would be identified.

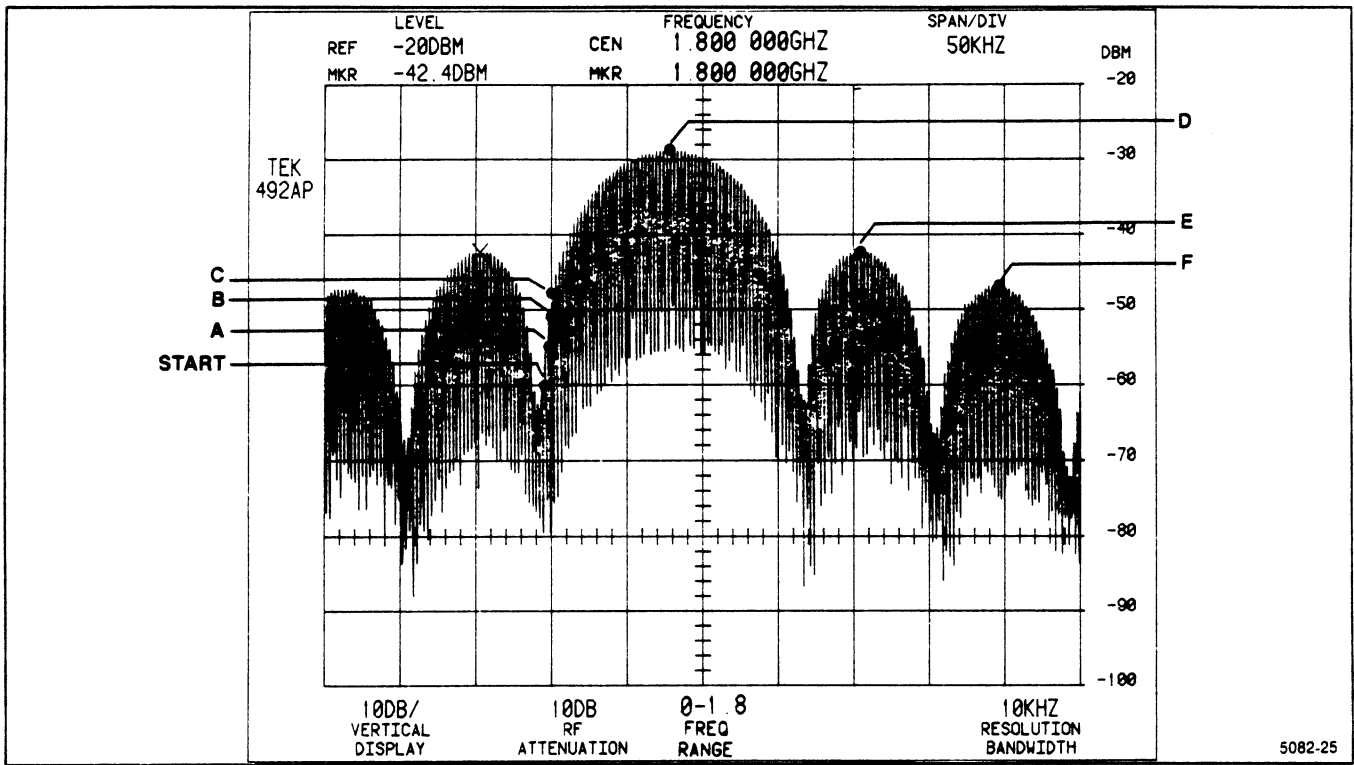

Figure 4-6. Signal finding example.

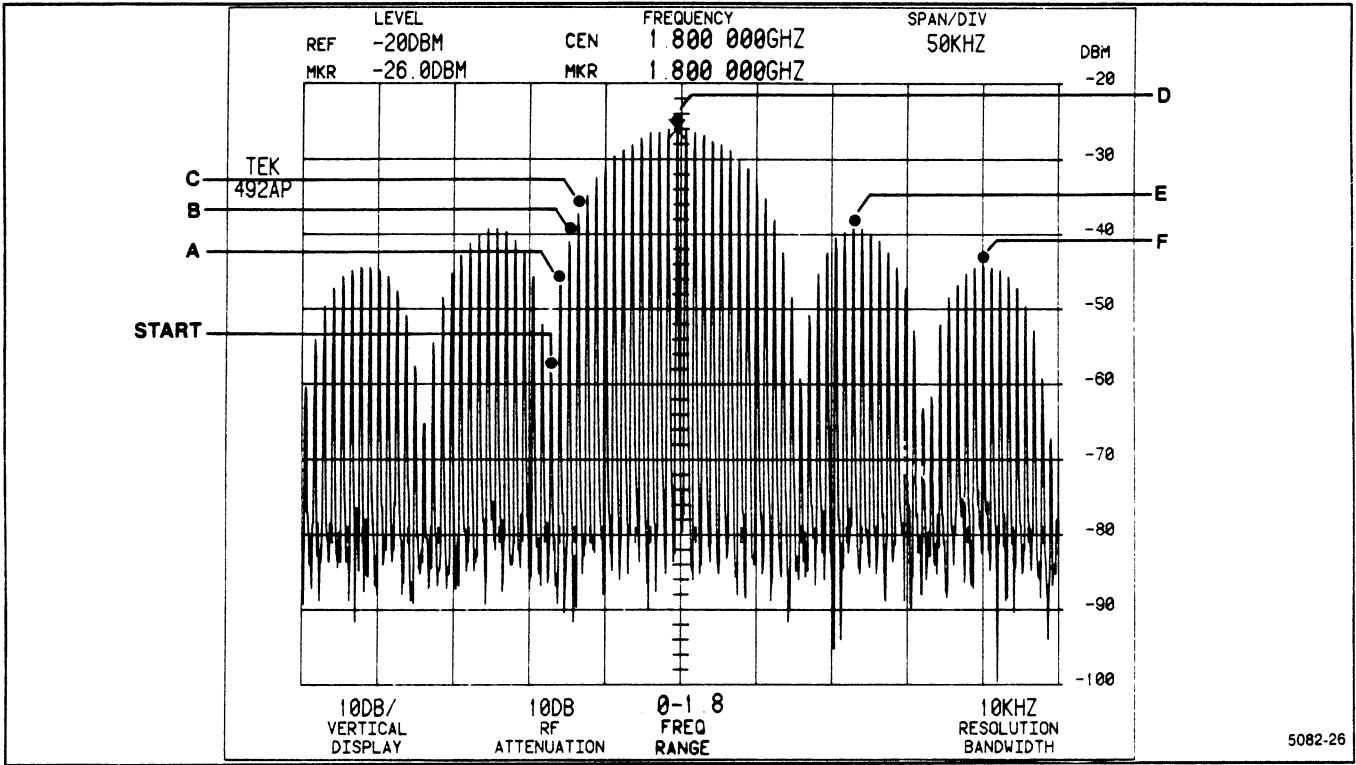

Figure 4-7. Signal finding example.

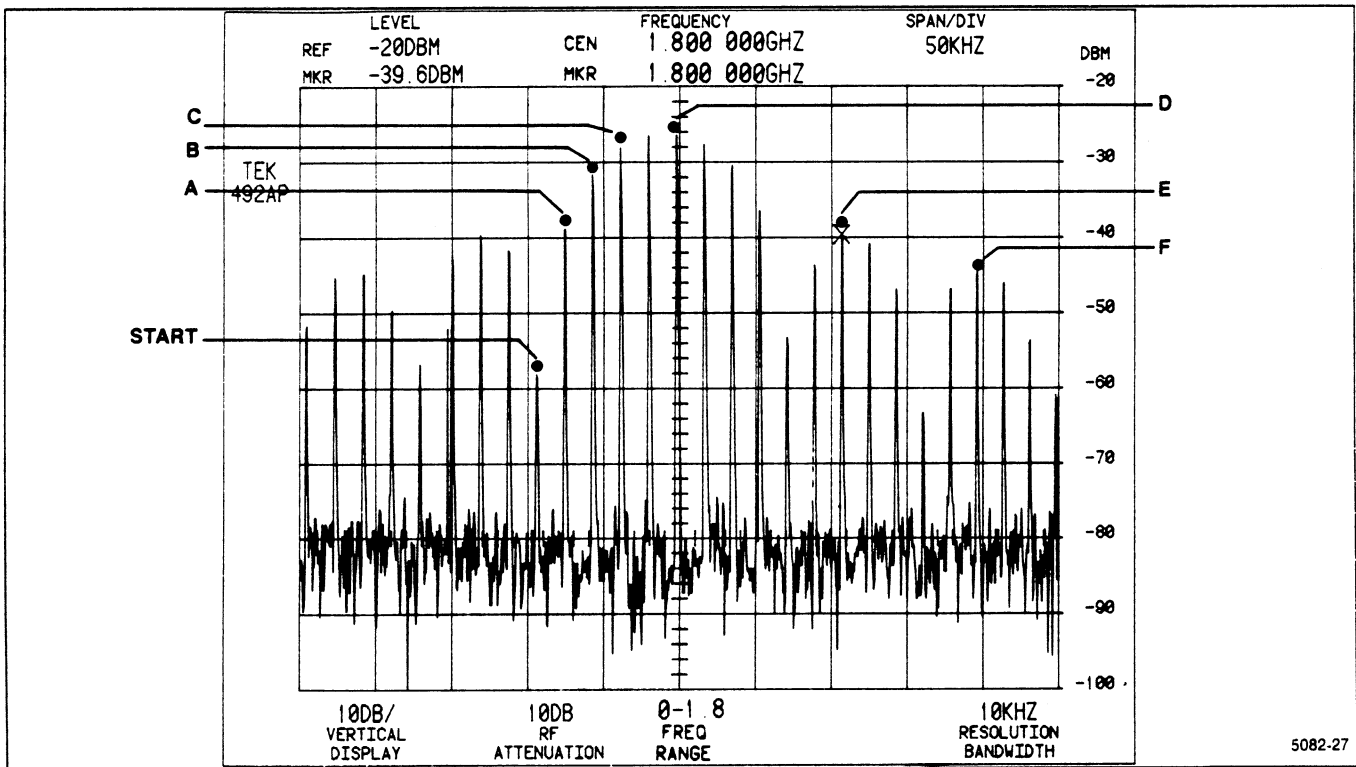

Figure 4-8. Signal finding example.

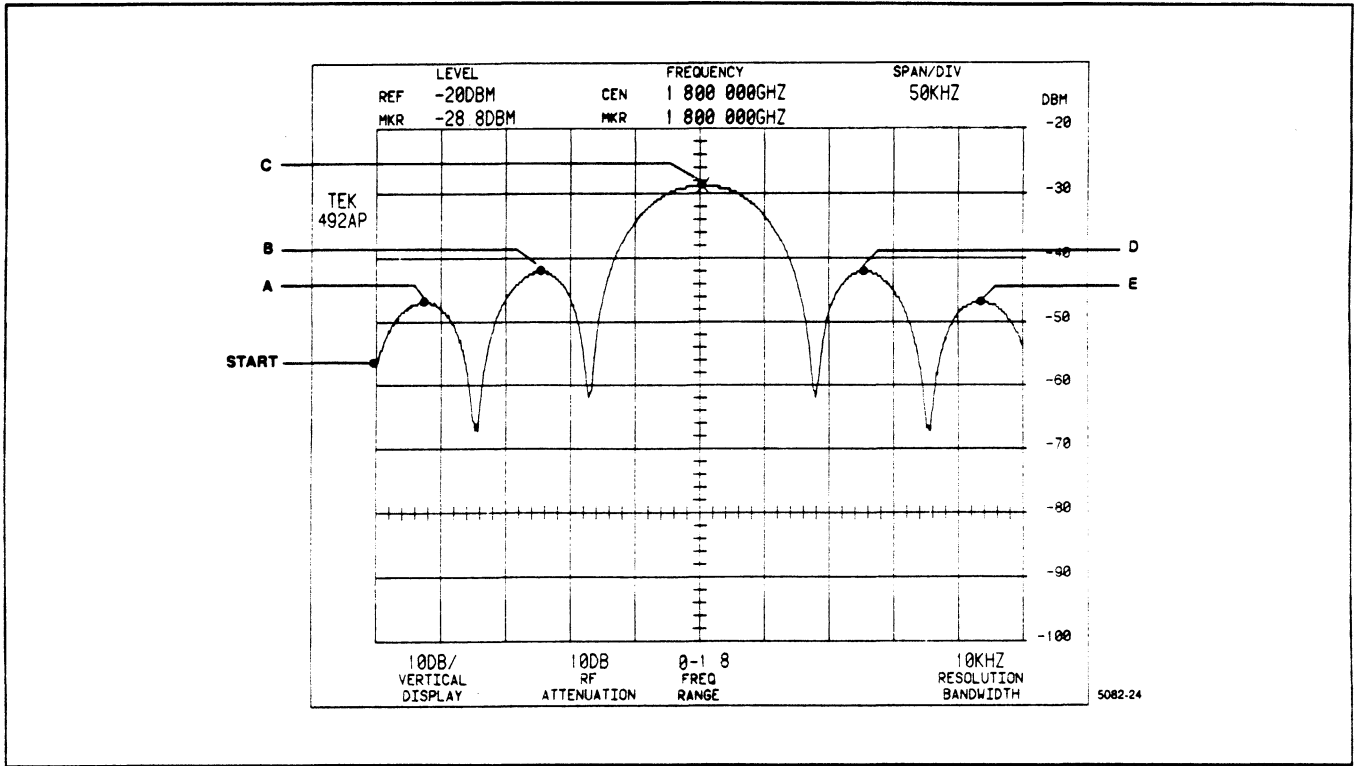

Figure 4-9. Signal finding example.

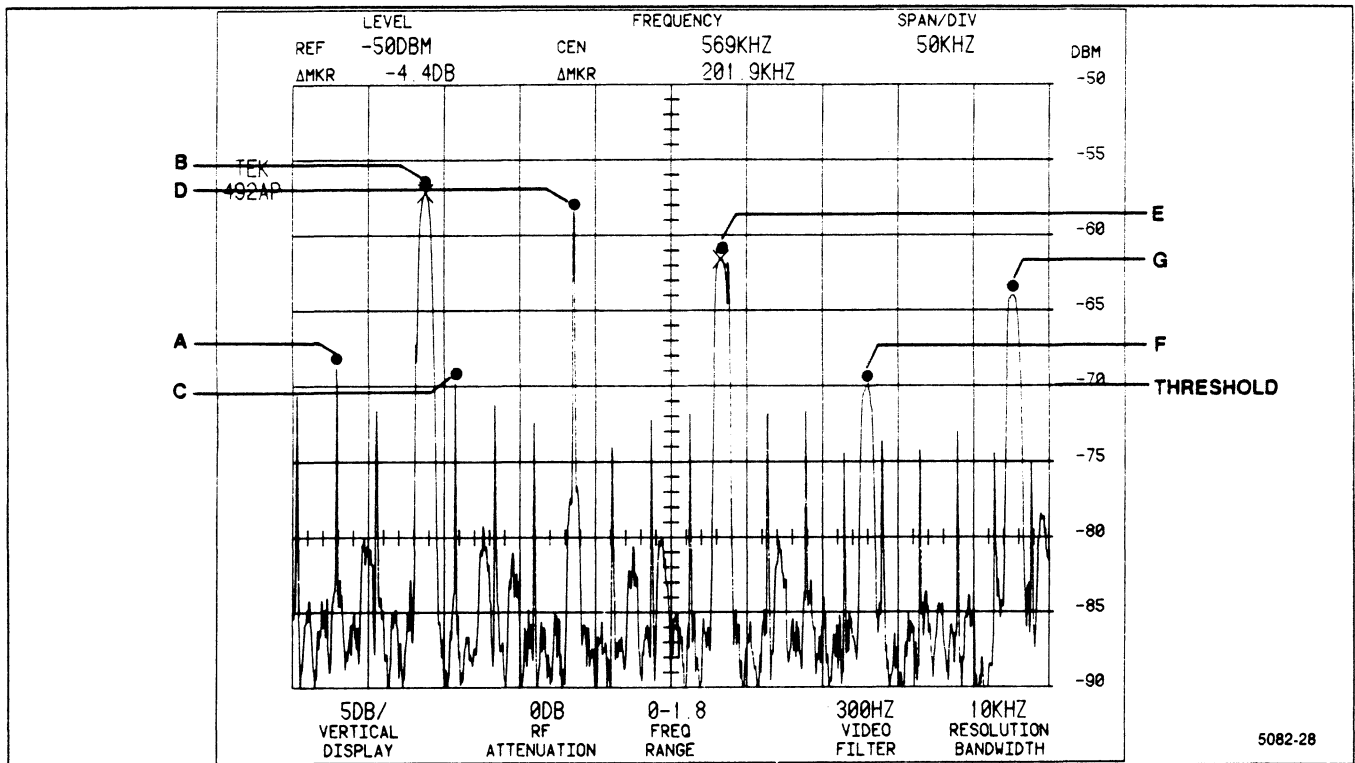

Figure 4-10. Signal finding example.

DISPLAY PARAMETERS

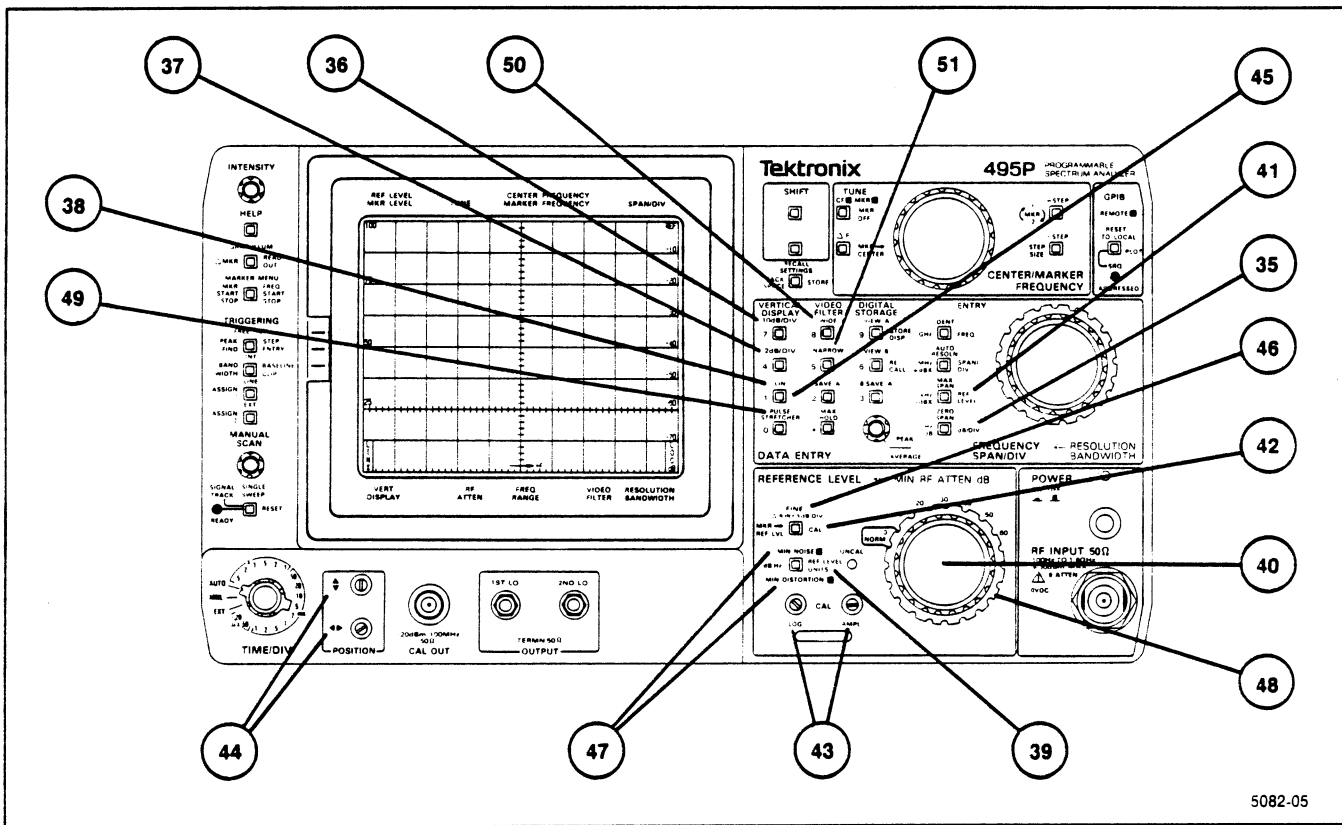
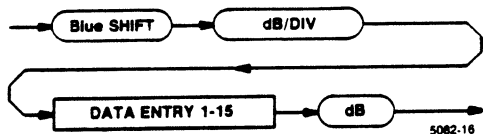

Figure 4-11

35 <Blue-SHIFT> dB/DIV — This pushbutton sequence allows direct entry of the desired amplitude display factor. The range is 1 to 15 dB/div in 1 dB increments. Although a display with greater than an 80 dB range can be selected, the actual measurement range will not exceed 80 dB. Numbers outside the allowable range will be ignored. Terminate the dB/div number entered with the dB pushbutton.



VERTICAL DISPLAY — These three pushbuttons select the vertical display factors. The crt readout indicates the selection. The vertical display factor, in the Log mode, can also be entered with the DATA ENTRY pushbuttons.

36 10 dB/DIV — With this pushbutton activated, the dynamic range of the display is a calibrated 80 dB with each major graticule division representing 10 dB.

37 2 dB/DIV — This pushbutton increases resolution so that each major graticule division represents 2 dB. Display dynamic range is 16 dB.

38 LIN — With this pushbutton activated, a linear display between zero volts (bottom graticule line) and the reference level (top graticule line), scaled in volts/division, is selected (see the REFERENCE LEVEL description).

39 <Blue-SHIFT> REF LEVEL UNITS — This pushbutton sequence allows the selection of reference level units to be dBm, dBV, dBmV, or dB μ V.

40 REFERENCE LEVEL — This control changes the reference level one step for each stop. Automatic selection of the IF gain and RF attenuation provide for the best overall noise and distortion perfor-

mance. In the Log Vertical Display mode, when FINE is not activated, the step size equals the selected dB/div factor; except for 2 dB/div, where step size is 1 dB. When FINE is activated, the step size is 1 dB for dB/div factors of 5 or more and 0.25 dB for Vertical Display factors of less than 5 dB/div. When the display factor is less than 5 dB/div and FINE is activated, the Delta A mode is selected. Refer to Section 6 for a description of the Delta A mode.

- 41 **<Blue-SHIFT> REF LEVEL** — This pushbutton sequence allows direct entry of reference level, with 1 dB resolution. The range is +30 dBm to -117 dBm (+40 dBm if the Minimum Noise mode is selected). Values entered outside this range are ignored (values will be in the selected units; dBm, dBV, dBmV, or dBuV). Either the +dBx or -dBx pushbutton terminates the reference level numbers entered.

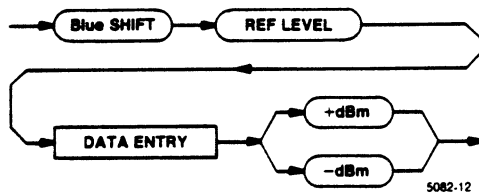

- 42 **<Blue-SHIFT> CAL** — This pushbutton sequence starts a frequency and reference level measurement procedure that uses the spectrum analyzer calibrator. Messages on the crt screen will guide you through the adjustments of vertical and horizontal POSITION, and LOG and AMPL CAL. The spectrum analyzer then runs an automatic frequency, bandwidth, and relative amplitude measurement routine for the resolution bandwidth filters.

The frequency measuring routine adjusts center frequency by measuring the frequency of each resolution bandwidth filter to reduce center frequency variation when changing resolution bandwidth. The relative amplitude measuring routine reduces reference level variation when changing Resolution Bandwidth. To ensure that the instrument meets frequency and amplitude performance characteristics, run these routines whenever the instrument's surrounding temperature changes significantly. Cal factors that are used internally to correct for the errors measured by this function are retained in memory when the instrument power is off. To display these factors, press <blue-SHIFT> LIN.

- 43 **LOG and AMPL CAL** — These screwdriver adjustments calibrate the vertical portion of the display. LOG CAL adjusts the logarithmic gain in dB/div,

and AMPL CAL adjusts the display amplitude. Press <blue-SHIFT> CAL to initiate a procedure that will guide you through these adjustments, as well as the vertical and horizontal POSITION adjustments. Refer to <blue-SHIFT> CAL for additional information.

- 44 **POSITION** — These screwdriver adjustments position the display along the horizontal and vertical axes. The <blue-SHIFT> CAL pushbutton sequence will guide you through the adjustment of these controls. Refer to <blue-SHIFT> CAL for additional information.

- 45 **<Blue-SHIFT> LIN** (Self-Measurement Results; not identified on the front panel) — The factors used to internally correct for frequency and amplitude errors are displayed. The factors shown are as measured with the last <blue-SHIFT> CAL operation. If one of the factors could not be measured at the last operation, the old value will be noted. This means that the previously measured value is used. If < or > appears next to the amplitude calibration factor, it means that this filter's amplitude related to the 1 MHz filter is outside the range of correction (correction is set to the limit). Press <blue-SHIFT> to exit.

- 46 **FINE (Δ A IN <5 dB/DIV)** — This pushbutton selects step size for the REFERENCE LEVEL control. When FINE is off, step size is equal to 10dB/div, except 2 dB/div where step size is 1 dB. When FINE is on, step size is 1 dB for display factors of 5 dB/div or more, and 0.25 dB for display factors of less than 5 dB/div. When step size is 0.25 dB, the Delta A mode is selected. The crt Ref Level readout goes to 0.00 dB, and the REFERENCE LEVEL control steps in 0.25 dB increments. These fine steps provide the means to make accurate relative amplitude measurements over a 48 dB measurement range. Refer to Delta A mode operation in Section 6 for more details.

- 47 **MIN NOISE/MIN DISTORTION**

MIN NOISE (pushbutton lit) — In this mode, the noise level is reduced by changing the RF attenuation and IF gain used for a particular reference level. Both are reduced 10 dB so noise generated in the IF stages is decreased; however, intermodulation distortion products will increase. RF attenuation must be at least 10 dB for this control to have any effect.

MIN DISTORTION (pushbutton not lit) — In this mode, intermodulation distortion products are minimized. This is the usual operating mode.

- 48 **MIN RF ATTEN dB** — This control specifies the lowest value of input attenuation that will be used when REF LEVEL is selected. This allows operator-control to protect the front end of the analyzer against overload and/or damage from excessive signal level into the 1st mixer. Actual attenuation is set according to the MIN RF ATTEN dB, REFERENCE LEVEL, and MIN NOISE/MIN DISTORTION selections and is displayed on the crt readout. If the MIN RF ATTEN dB setting is increased, the IF gain is automatically changed to maintain the current reference level, if possible. The normal position is 0 to obtain the best noise level performance.
- 49 **PULSE STRETCHER** — This pushbutton causes the fall-time of pulse signals to be increased so very narrow pulses can be seen. The effect is most apparent for pulsed RF signals where pulse width is small compared to one division of sweep time. Pulse stretcher operation may be necessary for a digital storage display of such signals, to ensure that the correct amplitude is displayed.

VIDEO FILTER

- 50 **WIDE** — This pushbutton reduces video bandwidth and high-frequency components for display noise averaging. The video bandwidth selected is approximately 1/30th of the selected resolution bandwidth (1/10 for 30 Hz). Selecting WIDE cancels NARROW. The filter value is displayed in the lower readout.
- 51 **NARROW** — This pushbutton reduces video bandwidth and high-frequency components for display noise averaging. The video bandwidth selected is approximately 1/300th of the selected resolution bandwidth (1/100 for 30 Hz). Selecting NARROW cancels WIDE. The filter value is displayed in the lower readout.

SWEEP

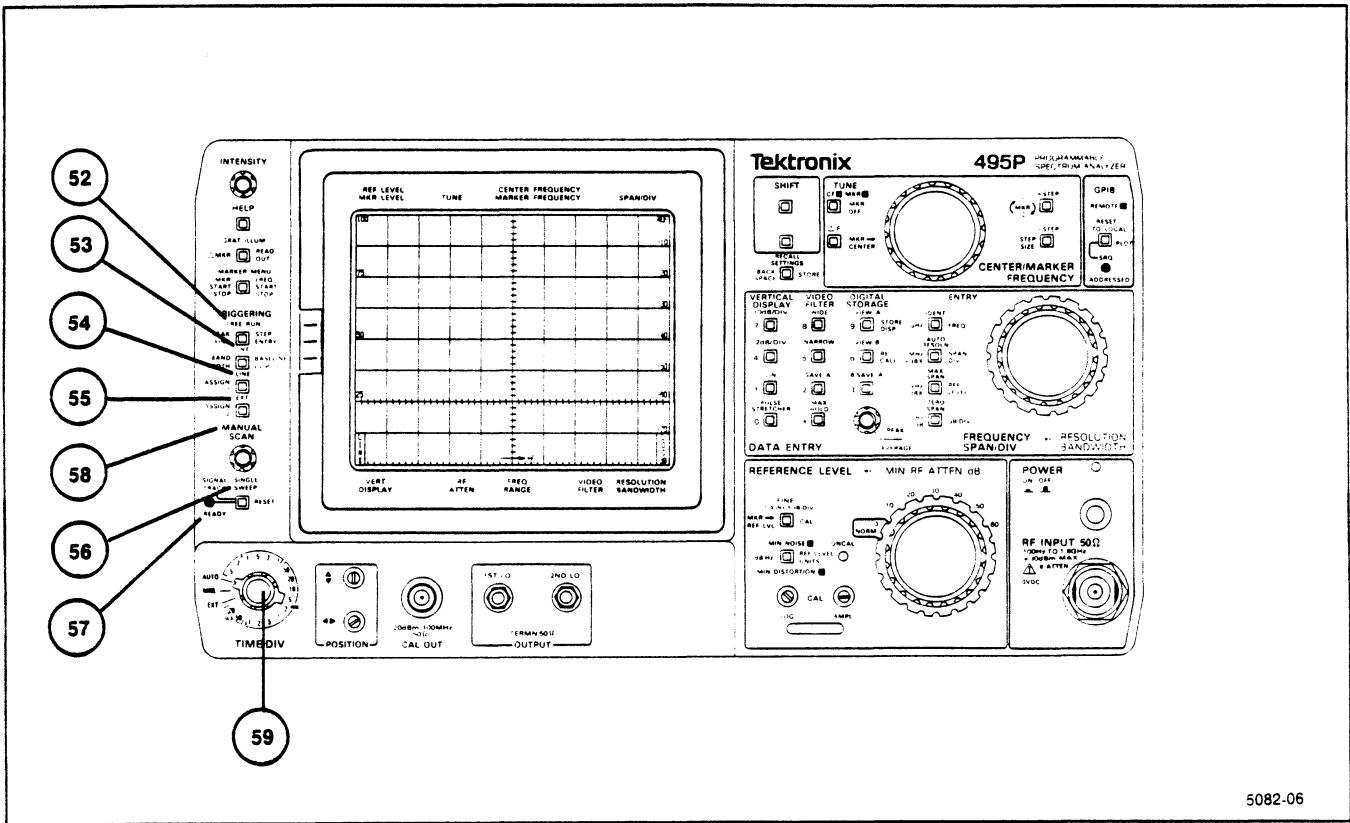

Figure 4-12

TRIGGERING

- 52 **FREE RUN** — This pushbutton allows the sweep to free run without regard to trigger source. Other TRIGGERING selections are cancelled, including single-sweep.
- 53 **INT** — This pushbutton allows the sweep to be triggered by any signal at the left edge of the display that has an amplitude of 2.0 divisions or more. Other TRIGGERING selections are cancelled, including single-sweep.
- 54 **LINE** — This pushbutton allows a sample of the ac power line voltage to trigger the sweep. Other TRIGGERING selections are cancelled, including single-sweep.
- 55 **EXT** — This pushbutton allows the sweep to be triggered by signals that are applied through the rear-panel HORIZTRIG (EXT IN) connector. Other TRIGGERING selections are cancelled, including single-sweep.
- 56 **SINGLE SWEEP** When first pressed, this pushbutton activates the single-sweep mode and stops the current sweep. When pressed again, the sweep trigger circuit is armed and the READY indicator is lit. The sweep will run only after it receives a trigger signal. When SINGLE SWEEP is selected, the TRIGGERING selection (i.e., FREE RUN, INTERNAL, LINE, or EXTERNAL) is not changed. Select any TRIGGERING selection to cancel SINGLE SWEEP.
- 57 **READY** (only used in the Single Sweep mode) — This indicator lights when the trigger circuit is armed and ready for a trigger signal. It remains lit until the sweep ends.
- 58 **MANUAL SCAN** — With TIME/DIV in the MNL position, rotate this control to Manually scan the spectrum.
- 59 **TIME/DIV** — This control selects sweep rates from 5 s/div to 20 us/div, in a 1-2-5 sequence, in addition to AUTO, G+, and EXTERNAL sweeps.

5082-06

AUTO (automatic) — This position allows the sweep rate to be selected automatically to maintain a calibrated display for most FREQUENCY SPAN/DIV, RESOLUTION BANDWIDTH, VIDEO FILTER, and Vertical Display selections.

EXT (external sweep) — This position allows the sweep circuit to be driven by a signal applied to the rear-panel HORIZ|TRIG (EXT IN) connector. A voltage ramp of 0 to +10 V will sweep 10 divisions of horizontal (X) axis.

MNL (Manual) — This position allows the spectrum or display to be manually swept with the MANUAL SCAN control.

DIGITAL STORAGE

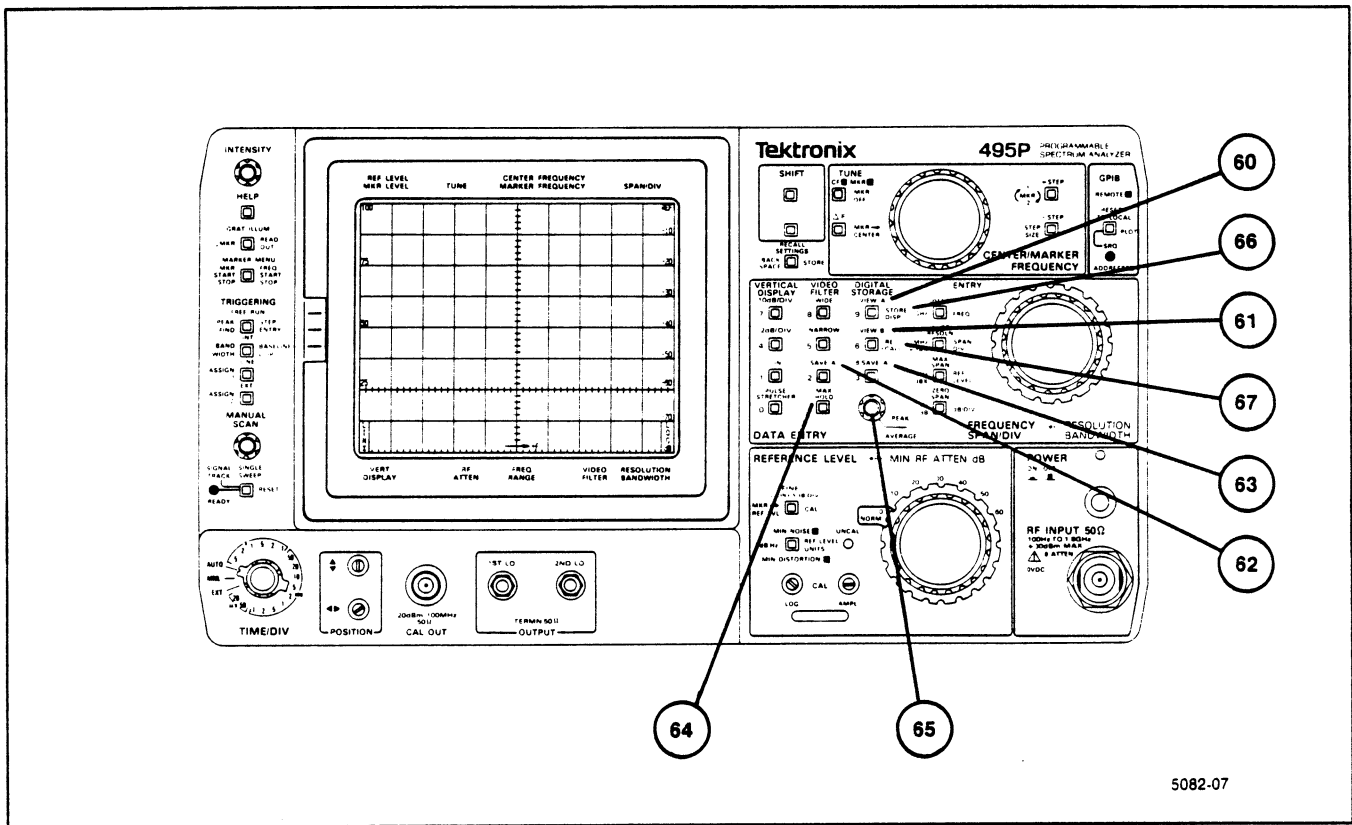

Figure 4-13

DIGITAL STORAGE — These pushbuttons allow either or both sections of memory to be selected to provide digital storage. When VIEW A and VIEW B are activated, contents of both the A and B memories are displayed on the screen. Both sections are updated with each sweep.

- 60 **VIEW A** — This pushbutton causes the A waveform to be displayed. If SAVE A is on and only the A waveform is being viewed, the crt readout will show the settings when the A waveform was stored.
- 61 **VIEW B** — This pushbutton causes the B waveform to be displayed.
- 62 **SAVE A** — This pushbutton saves the A waveform and its readout. The readout stored with the waveform is displayed if both SAVE A and VIEW A are on and VIEW B and B-SAVE A are off; if either VIEW B or B-SAVE A is on, the readout reflects the current spectrum analyzer settings. Turning SAVE A off cancels B-SAVE A, if it is on. If SAVE A is off and either VIEW A

or VIEW B is on, both waveforms will be displayed. The A waveform is not updated by the sweep if SAVE A is on.

- 63 **B-SAVE A** — When activated, the spectrum analyzer displays the difference between the B waveform and the A waveform and automatically turns on SAVE A. The factory-set zero reference line is mid-screen, and positive differences are displayed above this line and negative differences below. Refer any change in the position of the zero reference line to authorized service personnel.
- 64 **MAX HOLD** — This pushbutton causes digital storage to retain the maximum signal amplitude at every storage location (500 locations; or 1000 locations if SAVE A is off). If SAVE A is on, the A waveform is not affected. Use MAX HOLD to measure frequency drift or peak amplitude excursions of a signal.

65 PEAK/AVERAGE — This control selects the vertical position (shown on the screen by a horizontal line) at which digital storage switches from peak detection to signal averaging. Video signals above the cursor are peak detected; video signals below the cursor are digitally averaged.

Store/Recall

66 <Blue-SHIFT> STORE DISP — This pushbutton sequence starts a multiple-pushbutton sequence that stores either the A or B waveform and its associated readout and marker(s) in a numbered (0 through 8) memory register. Information is held in memory while instrument power is off. Messages displayed on the crt aid in completing the multiple-pushbutton sequence. After selecting <blue-SHIFT> STORE DISPlay, a list of the center frequencies of stored displays is shown. The number of digits in a center frequency in the menu list is an indication of the span/div of that stored display (a larger number of digits indicates a narrower span). This display includes a prompt asking for the register number (0–8) into which the display will be stored. Select the register from the DATA ENTRY pushbuttons. When SAVE A is on, there is an operator prompt that asks whether the A or B waveform is to be saved.

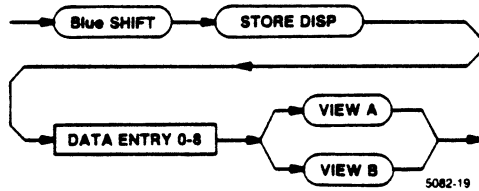

67 <Blue-SHIFT> RECALL — This pushbutton sequence starts a multiple-pushbutton sequence that recalls a selected waveform, with its readout and marker(s) from one of the memory registers (0 through 8) and puts it in either the A or B display, for viewing. Information is held in memory while the instrument is off. After selecting <blue-SHIFT> RECALL, a list of center frequencies of stored displays is shown. This display includes a prompt asking for the register number (0–8) from which the display will be recalled. Select the register from the DATA ENTRY pushbuttons. The readout for a recalled A waveform will only be displayed if VIEW B and B–SAVE A are off and VIEW A is on. The readout for a recalled B waveform will only be displayed if both VIEW B or B–SAVE A are on and SINGLE SWEEP is selected. The marker(s) will only be displayed if markers are turned on.

SAVE A is activated to allow the separate display of the A or B waveform. Remember to turn on SINGLE SWEEP before recalling a waveform to B to prevent overwrite by the sweep. The waveform cannot be recalled into B when in Manual or External Sweep. Press <blue-SHIFT> to exit during the sequence.

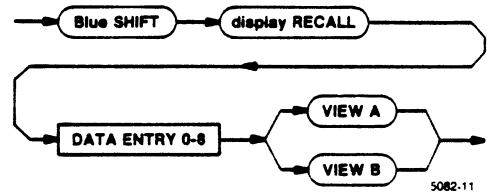

DISPLAY AND GENERAL PURPOSE

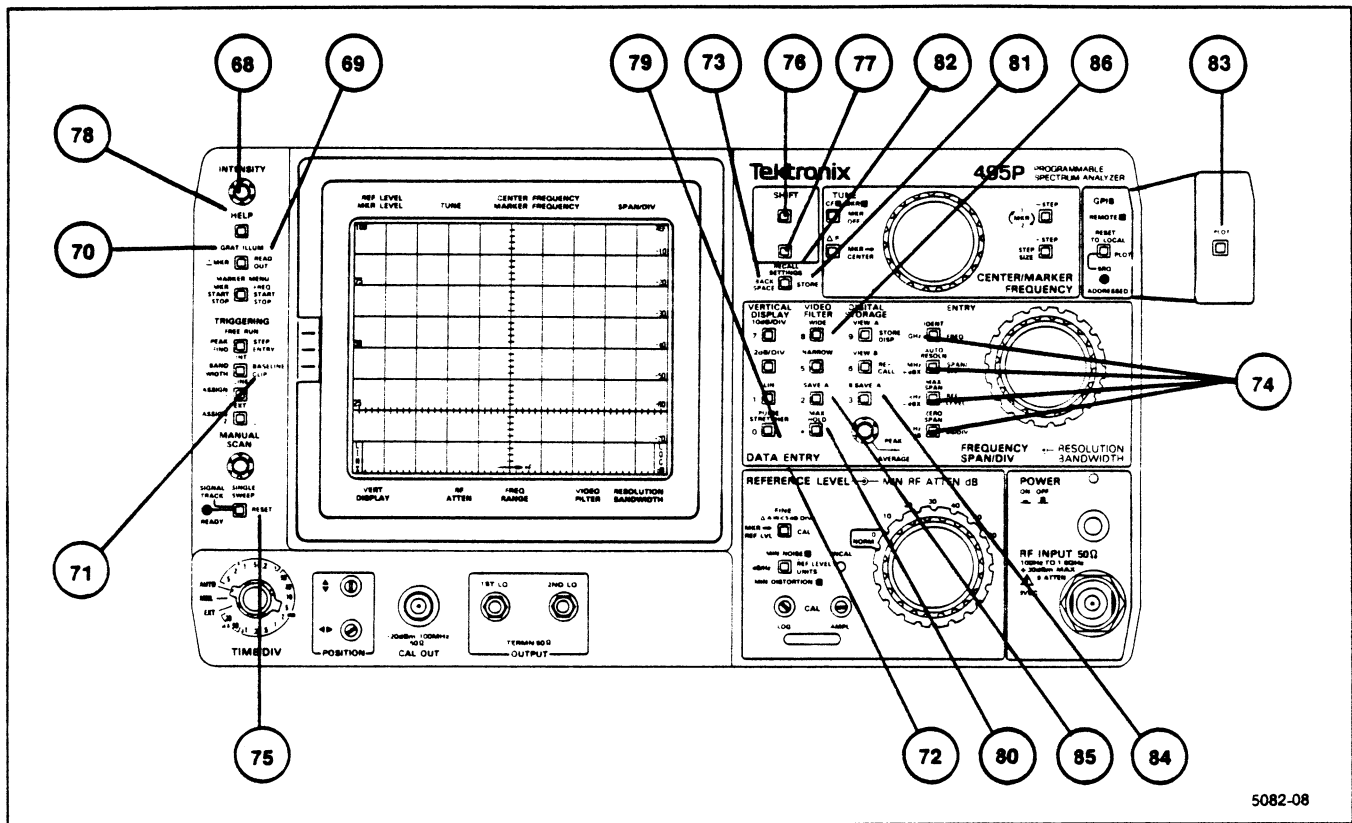

Figure 4-14

- 68 INTENSITY** — This control adjusts the brightness of the crt trace, readout, and text. Beam focus is automatically controlled.
- 69 <Blue-SHIFT> READOUT** — This pushbutton turns crt readout on and off. The brightness is proportional to the trace brightness. This pushbutton does not affect prompt or help messages.
- 70 GRAT ILLUM** — This pushbutton switches the graticule lights from dim for low-light viewing to bright for photographing displays.
- 71 <Blue-SHIFT> BASELINE CLIP** — This pushbutton clips, or blanks, about one graticule division of the spectrum trace at the baseline of the display. Use BASELINE CLIP to observe the readout at the bottom of the screen or to eliminate the bright baseline when photographing displays.
- 72 DATA ENTRY** — These orange pushbuttons are used to enter data directly from the front panel when directed by a message on the crt.
- Numbers** — The numbers 0 through 9 and a decimal point are available to enter data from the front panel.
- 73 BACKSPACE** — This pushbutton backs the cursor up one space each time it is pressed, erasing the number in that location. This allows you to enter correct numerical data before finishing the sequence with a units pushbutton.
- 74 Units** — The units GHz, MHz, kHz, Hz, +dBx, -dBx, and dB are available to complete a number-entry function from the front panel.
- 75 <Blue-SHIFT> RESET** — This pushbutton sequence resets all front-panel settings to their original condition as if power was just turned on.

76 <Blue-SHIFT> — This pushbutton allows selection of the blue-labeled front-panel pushbutton functions. Press <blue-SHIFT> each time before selecting a blue-lettered function. <Blue-SHIFT> also stops multiple-pushbutton sequence operations.

77 <Green-SHIFT> — This pushbutton allows selection of the green-labeled front-panel pushbutton functions. Press <green-SHIFT> each time before selecting a green-lettered function. <Green-SHIFT> also stops multiple-pushbutton sequence operations.

78 HELP — This pushbutton causes text to be displayed on the crt to explain the function of a selected front-panel control or pushbutton. Press the HELP pushbutton, then press any pushbutton or turn most controls for an explanation of their function. Explanations are not available for the PEAK/AVERAGE, INTENSITY, or MANUAL SCAN controls. Press HELP again to exit.

<Blue-SHIFT> HELP — This pushbutton sequence allows selection of all explanations for functions called out on the front panel in blue. <Blue-SHIFT> HELP only needs to be pressed once to begin the selection (i.e., <blue-SHIFT> HELP, REF LEVEL, PLOT, READOUT). Press HELP again to exit this mode.

<Green-SHIFT> HELP — This pushbutton sequence allows selection of all explanations for functions called out on the front panel in green. <Green-SHIFT> HELP only needs to be pressed once to begin the selection (i.e., <green-SHIFT> HELP, SIGNAL TRACK, PEAK FIND, MKR START STOP). Press HELP again to exit this mode.

For additional information on HELP, see Using the HELP Feature in Section 6.

79 <Blue-SHIFT> PULSE STRETCHER (Diagnostic Aids; not identified on the front panel) — This pushbutton sequence displays a menu on the crt of all the available diagnostic aids for use while troubleshooting.

WARNING

MOST OF THIS INFORMATION IS FOR QUALIFIED SERVICE PERSONNEL ONLY. UNFAMILIARITY WITH SAFETY PROCEDURES CAN RESULT IN PERSONAL INJURY. PERFORM ONLY THE OPERATIONS THAT CAN BE COMPLETED FROM THE INSTRUMENT FRONT PANEL. DO NOT ATTEMPT TO REMOVE THE INSTRUMENT PANELS OR PERFORM ANY INTERNAL

OPERATIONS; CONTACT QUALIFIED SERVICE PERSONNEL.

80 <Blue-SHIFT> MAX HOLD (Instrument Errors; not identified on the front panel) — This pushbutton sequence displays on the crt all the detected instrument errors; for use while troubleshooting.

81 <Blue-SHIFT> STORE — This pushbutton sequence allows a front-panel setup to be stored in memory. Up to ten settings can be stored in registers 0-9. The crt displays a list of center frequencies of each setup as an aid in identifying the contents of each register. Select the desired register, and the setup is stored. The instrument settings are automatically stored in register 0 when the spectrum analyzer is turned off, overwriting the settings previously stored there.

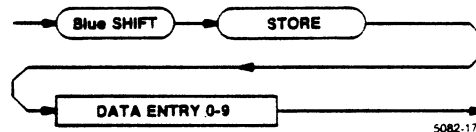

82 RECALL SETTINGS — This pushbutton recalls an instrument front-panel setup from memory. The crt displays a list of the center frequencies of each stored setup as an aid in identifying the contents of each register (0-9). The time and minimum RF attenuation settings stay at the knob values. Select the desired register number, and the front-panel controls automatically switch to that setup. The instrument settings are automatically stored in register 0 when the spectrum analyzer is turned off, overwriting the settings previously stored there. To return to these settings, press RECALL SETTINGS 0.

83 PLOT — (495 Only) This pushbutton causes display information to directly drive a plotter. The plotters that can be driven are a Tektronix 4662 Option 01, 4662 Option 31, or 4663 (emulating the 4662); a Hewlett Packard HP7470A, HP7475A, HP7580B, HP7585B, or HP7486B, or a Gould 6310 or 6320. The plotter type is selected by pressing the <blue-SHIFT> SAVE A pushbutton sequence. Refer to Plotting The Display in Section 6 for details.

- 84 <Blue-SHIFT> B-SAVE A (Plot B-Save A Offset; not identified on the front panel) — The vertical position of the zero reference line for the B-SAVE A display is set with an internal switch selection. However, when using the PLOT function, the position of zero reference for the plot must be entered using this function. The range for the position is 0 to 255 with 125 representing center screen. Enter the position with the DATA ENTRY pushbuttons when prompted by the crt message, and terminate with the Hz pushbutton. The entered position is then stored in memory.

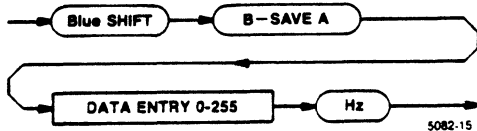

- 86 <Blue-SHIFT> VIDEO FILTER WIDE (Special Modes Menu; not identified on the front panel) — This pushbutton sequence brings up a menu from which you can select the special modes available within the instrument. The two available modes are the Tracking Generator Mode and the Sideband Analyzer Mode.

- 85 <Blue-SHIFT> SAVE A (Select Plotter Type; not identified on the front panel) — This pushbutton sequence displays the list of the plotter types available for use with the PLOT pushbutton (495 only) and <blue-SHIFT> PLOT pushbutton sequence (495P only). Select the desired plotter type by choosing one of the menu items and entering the number on the DATA ENTRY pushbuttons. The choices are 0=Tektronix 4662 Option 01 or the 4663 in a one-pen setup; 1=Tektronix 4662 Option 31 or the 4663 in a two-pen setup; 2=HP7470A or Gould 6310 or 6320; or 3=HP7475A, HP7580B, HP7585B, or HP7586B. Any plotter that is compatible with one of these can also be used. The selected plotter type is stored in memory.

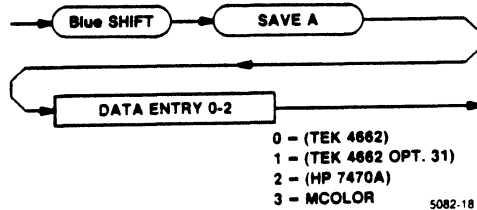

FRONT-PANEL INPUT/OUTPUT AND GPIB

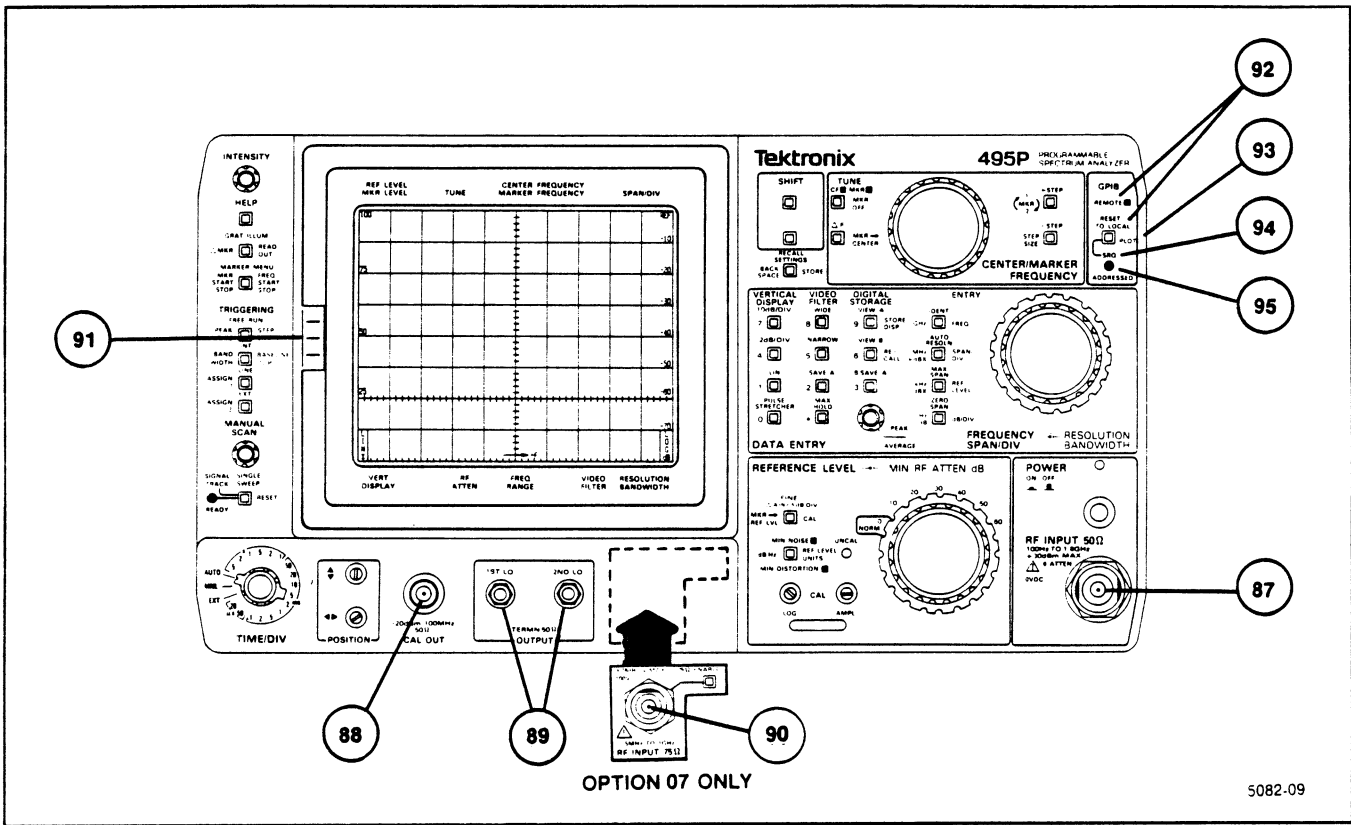

Figure 4-15

- 87 **RF INPUT 50 Ω** — This 50 Ω coaxial input connector is for RF signals to 1.8 GHz. If the input signal has a dc component, use a blocking capacitor in line with the signal.

CAUTION

The maximum, non-destructive input signal level to the input mixer is +13 dBm or 20 mW.

The maximum rating of the RF attenuator is +30 dBm (1 W average, 75 W peak pulse width 1 ms or less, with a duty cycle that does not exceed 0.001). Burn-out occurs above 1 W. If MIN NOISE is activated and the RF ATTEN is 60 dB, the +30 dBm rating will be exceeded if the signal level is increased to a full-screen display. Under these conditions the input level will be +40 dBm. Reduce the level of high-powered signals with external attenuators. Input signals to the mixer must not contain any dc

component. Refer to Signal Application in Section 6.

- 88 **CAL OUT (Calibrator output)** — This connector is the source of a calibrated $-20 \text{ dBm} \pm 0.3 \text{ dB}$, 100 MHz signal and a comb of frequency markers 100 MHz apart. This 100 MHz source is the instrument reference frequency. In Option 07 instruments using the 50 Ω input, the signal is the same as the standard instrument, and using the 75 Ω input, the signal is +20 dBmV, $\pm 0.5 \text{ dB}$.
- 89 **OUTPUT (1ST LO/2ND LO)** — These connectors are the outputs of the respective local oscillators. The connectors must be terminated into 50 Ω when they are not connected to an external device.

- 90  **RF INPUT 75 Ω** (Option 07 instruments only)
— This connector provides calibrated 75 Ω measurement capability.
- 91 **Camera Power** — This connector is the source of power for the Tektronix C-50 Series Cameras that have electrically-actuated shutters (either the C-5 or the C-59 is recommended). Single-sweep reset is not provided.
- 92 **RESET TO LOCAL/REMOTE** — (495P Only) This pushbutton is lit when the spectrum analyzer is in the remote state. While the instrument is remote, the other front-panel controls are not active except for PEAK/AVERAGE, INTENSITY, and MANUAL SCAN. Indicators still reflect the current state of front-panel functions. This pushbutton is not lit when the spectrum analyzer is in the local state. While the spectrum analyzer is under local control, no GPIB messages are executed that would conflict with front-panel controls or change the waveforms in digital storage. See Programming Features in Section 6 for additional information.
- 93 **<Blue-SHIFT> PLOT** — (495P Only) This pushbutton sequence causes display information to be sent over the GPIB to directly drive a plotter. The plotters that can be driven are a Tektronix 4662 Option 01, 4662 Option 31, or 4663 (emulating the 4662); a Hewlett Packard HP7470A, HP7475A, HP7580B, HP7585B, or HP7486B, or a Gould 6310 or 6320. The plotter type is selected by pressing the <blue-SHIFT> SAVE A pushbutton sequence. Refer to Plotting The Display in Section 6 for details. This pushbutton also causes the spectrum analyzer to update the GPIB address.
- 94 **<Green-SHIFT> SRQ** — (495P Only) This pushbutton sequence sends a service request over the GPIB bus to the controller.
- 95 **ADDRESSED** — (495P Only) This indicator lights when the spectrum analyzer is addressed to either talk or listen. The characters T, L, and/or S appear in the crt readout to indicate talk, listen, and/or SRQ, respectively.

REAR-PANEL INPUT/OUTPUT AND GPIB

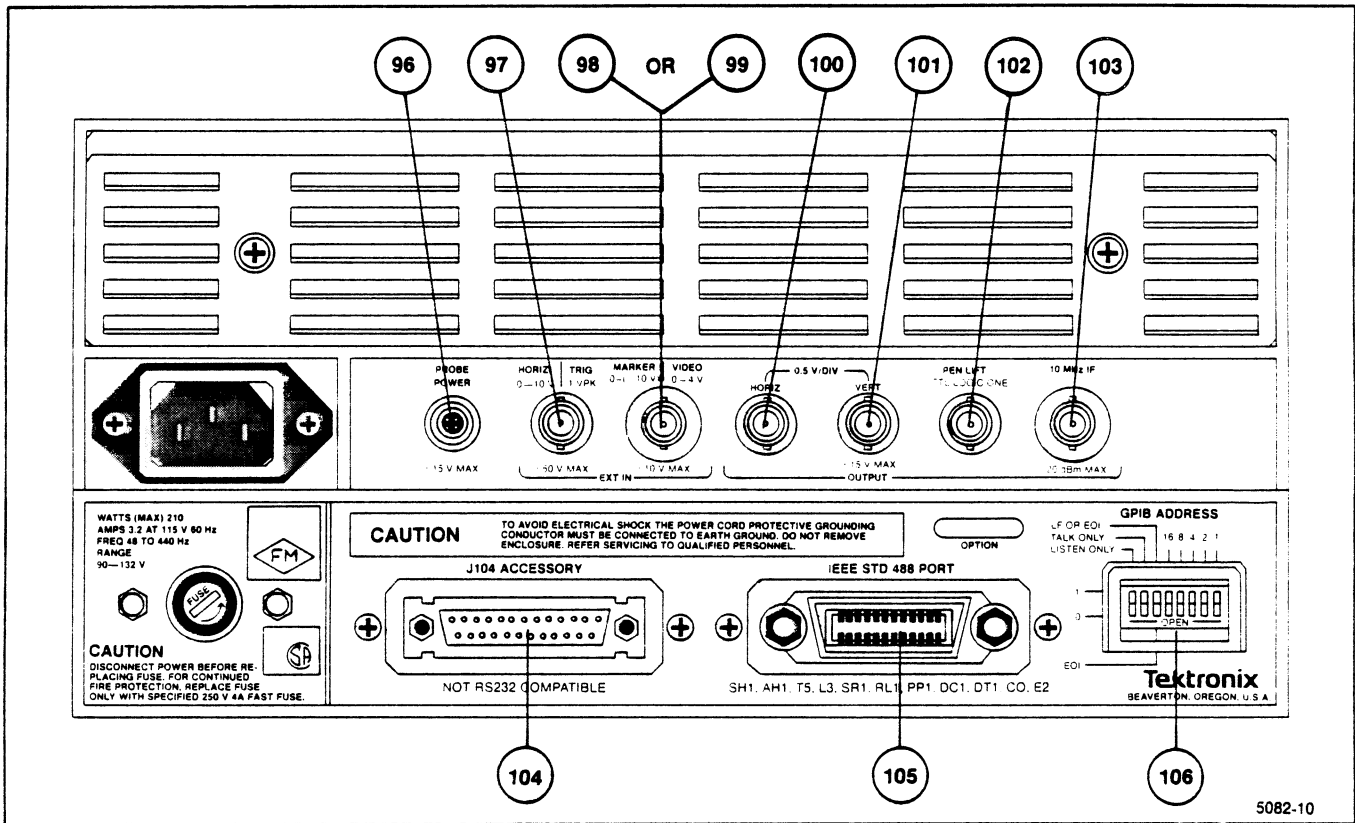

Figure 4-16

- 96 PROBE POWER** — This connector provides operating power for active probe systems. This connector should be used only with compatible probes or accessories specifically designed for use with this power source.
- 97 HORIZ|TRIG (EXT IN)** — Horizontal or triggering modes depend on the TRIGGERING and TIME/DIV selections. In the External Triggering mode, the connector is an ac coupled input for trigger signals. Trigger amplitudes from 1.0 V to 50 V peak, with a 0.1 μ s minimum pulse width or within the frequency range of 15 Hz to 1 MHz, are required for triggering. When the TIME/DIV selection is EXT, the connector is a dc coupled input for horizontal sweep voltages. Deflection sensitivity is 1 V/div. A 0 to +10 voltage will deflect the beam across the screen from left to right.
- 98 MARKER|VIDEO (EXT IN)** — (Available on instruments without Option 42 only. See 110 MHz IF for Option 42 instruments.) This connector interfaces the spectrum analyzer with a Tektronix 1405 TV Adapter to display an externally-generated marker.
- 99 110 MHz IF** — (Available on Option 42 instruments only.) This connector provides 110 MHz IF output with a bandwidth greater than 5 MHz. Input external video signals into the PEN LIFT connector.
- 100 HORIZ (OUTPUT)** — This connector supplies a 0.5 V/div horizontal signal. Full range is -2.5 V to $+2.5$ V. Source impedance is approximately 1 k Ω .
- 101 VERT (OUTPUT)** — This connector provides access to the video signal with 0.5 V for each division of displayed video that is above and below the center line. Source impedance is approximately 1 k Ω .

NOTE

Both HORIZ and VERT output signals are driven from digital storage if it is on. Both signals are driven from the analyzer sweep and video amplifier stage if digital storage is off.

102 PEN LIFT (OUTPUT) — This connector provides access to a TTL compatible signal to lift the pen of a chart recorder during spectrum analyzer sweep retrace. This signal is always derived from the spectrum analyzer sweep, regardless of the selection of the digital storage.

In Option 42 instruments, use this connector to input external video signals if pin 1 of the ACCESSORIES connector is grounded (refer any questions about this connection to qualified service personnel).

103 10 MHz IF (OUTPUT) — This connector provides access to the output of the 10 MHz IF.

104 J104 ACCESSORY — This connector provides bi-directional access to the instrument bus. It is not RS 232 compatible. A TTL 0 applied to pin 1 selects External Video. Video signals, which are applied to rear-panel MARKERVIDEO, are connected to the video path ahead of the video filters.

105 IEEE STD 488 PORT (GPIB) — This connector interfaces the 495

to the selected plotter, and interfaces the 495P to the GPIB bus. The interface functions provided in the 495 are SH1, AH0, T3, L0, SR0, RL0, PP0, DC0, DT0, and C0. The interface functions provided in the 495P are SH1, AH1, T5, L3, SR1, RL1, PP1, DC1, DT1, and C0.

106 GPIB ADDRESS — (495P Only) These switches set the value of the lower five bits of the instrument GPIB address; this value is the instrument's primary address. These switches also select the Talk Only and Listen Only operating modes, and the message terminator for input and output. Address 31 (11111) logically disconnects the spectrum analyzer from the bus. Address 0 (00000) is reserved for Tektronix 4050-Series controllers. If these switches are changed after the instrument is already active, press RESET TO LOCAL or <blue-SHIFT> PLOT to cause the spectrum analyzer to re-read them.

Details of how the switches are used in remote control are in the Programmers Manual.

*This Document is a complete Scan from the original
Tektronix manual
For enquiries about our complete
High quality line of technical Manuals in PDF
mailto : Qservice@otenet.gr*

**SEE
OTHER
SIDE**

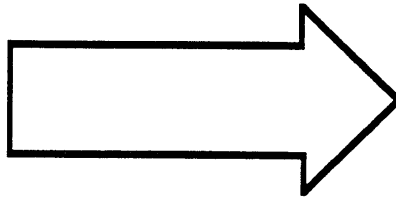

INSTRUMENT CHECK OUT

This section includes the basic instrument check-out procedures and first-time preparation for use. An instrument operational check is included for the front-panel pushbuttons and controls and some of the operating functions. No extra equipment is required to perform these check-out procedures, and the instrument covers do not need to be removed. Refer any additional instrument check out to qualified service personnel.

FIRMWARE VERSION AND ERROR MESSAGE READOUT

Firmware Version

When the spectrum analyzer is first turned on, all the front-panel LEDs will light up, and the front-panel processor firmware versions will be displayed on the screen for approximately two seconds.

Error Message Readout

If the instrument detects an internal hardware failure, a failure report comes on screen and remains for approximately 2 seconds. A status message then appears and remains for as long as the failure exists. Press HELP to bring error messages to the screen that explain the impact of the failure on instrument operation.

If the oscillator frequency cannot be set due to a hardware failure, it will continue to try each sweep, and the sweep holdoff time will increase with each try. To disable attempted oscillator corrections, press <blue-SHIFT> 10dB/DIV; however, center frequency accuracy specifications will not be met in this mode. Press <blue-SHIFT> 10dB/DIV again to re-enable oscillator correction routines. Another failure message will appear if the failure has not been corrected.

There are other error messages to report a calibration failure, power supply failure, and battery-operated RAM checksum error. Promptly report any error messages to qualified service personnel. (If you attempt to recall a display or setting from a location where nothing is stored, you will get a checksum error message even though there is not really an error, and this need not be reported to service personnel.)

PREPARATION FOR USE

The following procedure creates a display and calibrates center frequency readout, display reference level, and bandwidth. Whenever a SHIFT pushbutton is required in this procedure to precede a multiple-pushbutton sequence, it is enclosed in arrows; i.e. <blue-SHIFT>.

1. Initial Turn On

a. Connect the spectrum analyzer power cord to an appropriate power source (see Power Source And Power Requirements in Section 3 of this manual) and push the POWER switch ON.

When POWER is switched ON (power-up), the processor runs a memory and I/O test. If no processor system problems are found, the power-up program will complete in approximately 7 seconds, and the instrument will be ready to operate. The crt readout is functioning properly if it is as shown in Figure 5-1 after the 7-second power-up period. If a problem does exist within the instrument, a message will appear on the screen. To bypass the failed test and attempt to use the instrument, press the pushbutton as directed in the error message. However, performance may not be as specified.

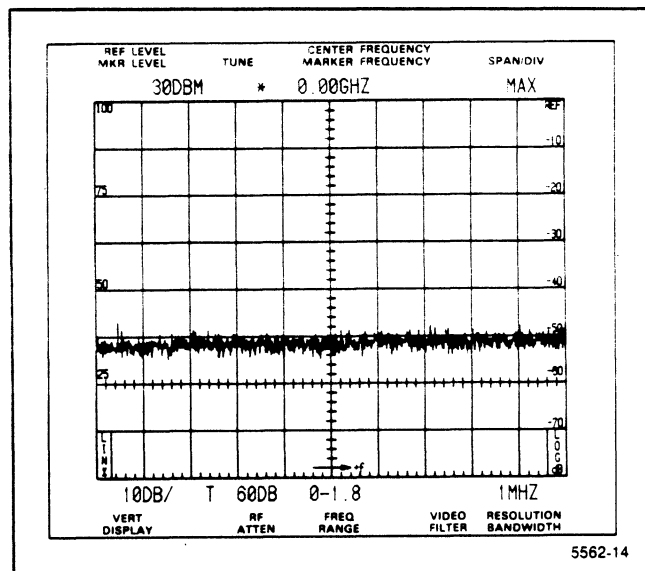

Figure 5-1. Crt display and readout at initial turn on.

The spectrum analyzer operating functions and modes will initialize to the following power-up states.

REF LEVEL	30 dBm
Center FREQUENCY	0.90 GHZ
Dot Marker FREQUENCY	0.00 GHZ
SPAN/DIV	MAXimum
VERTICAL DISPLAY	10 dB/DIV
RF ATTENUATION	60 dB
RESOLUTION BANDWIDTH	1 MHZ
TRIGGERING	FREE RUN
AUTO RESOLuTION	On
DIGITAL STORAGE	VIEW A/VIEW B On
All other pushbuttons	Inactive or Off

b. Set the MIN RF ATTEN dB control to 0 (NORM) and the PEAK/AVERAGE control fully counterclockwise. Set the TIME/DIV control to AUTO and the REF LEVEL to read -20 DBM, and adjust the INTENSITY control for the desired brightness. Note that the RF ATTENUATION readout is now 10 DB.

c. Connect a 50 Ω coaxial cable between the CAL OUT connector and RF INPUT to apply the CAL OUT signal to the RF INPUT connector.

d. A dot marker will appear in the upper portion of the screen in the MAX frequency mode. This marker indicates the location on the display to which the spectrum analyzer frequency is tuned. With a frequency readout of 0.00 GHz, the marker will be in the upper left portion of the screen. Rotate the CENTER/MARKER FREQUENCY control and watch the dot marker move across the display. Notice that the Center FREQUENCY readout (top line) remains at 0.90 GHz, and that the Marker FREQUENCY readout (second line) changes according to the position of the marker (dot).

e. A comb of 100 MHz markers will be displayed, as shown in Figure 5-2. To select 100 MHz center frequency, press the pushbutton sequence of <blue-SHIFT> FREQ 1 0 0 MHz.

f. To change the FREQ SPAN/DIV readout to 100 MHz, press the pushbutton sequence of <blue-SHIFT> SPAN/DIV 1 0 0 MHz. The dot marker is now horizontally centered, and the 100 MHz calibrator signal is at center screen.

2. Calibrate Position, Center Frequency, Reference Level, and Bandwidth

NOTE

When the <blue-SHIFT> CAL sequence is pressed, the spectrum analyzer performs a center frequency, bandwidth, and reference level calibration. Prompts appear on the screen to guide you step-by-step through the

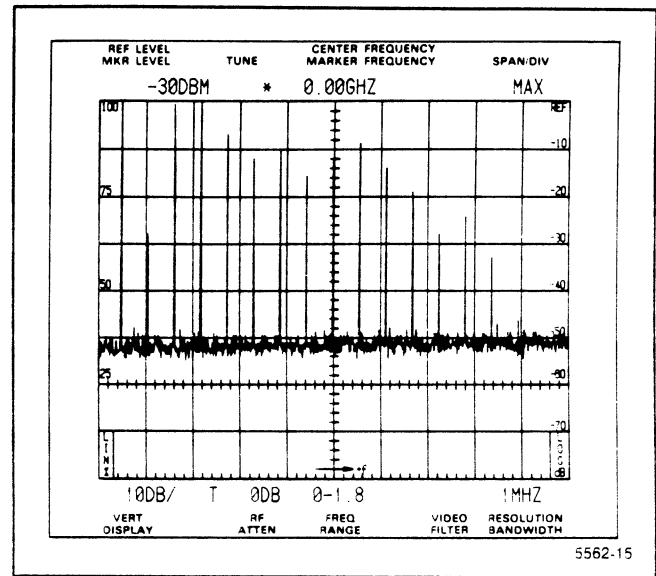

Figure 5-2. Typical display of calibration markers in the maximum span position.

procedure. This calibration should be done at regular intervals. It must be done before the instrument will meet its center frequency and reference level accuracy performance specifications. It should also be done any time the instrument ambient temperature is substantially different from the last calibration. An explanation of reference level accuracy with respect to ambient temperature is described in the Specification section of this manual.

To see the results after the spectrum analyzer has completed a calibration routine, press the <blue-SHIFT> LIN sequence. A message will appear on the screen that shows the correction factors used by the spectrum analyzer to center the resolution bandwidth filters to produce a calibrated center frequency. It also shows the correction that was required to bring the amplitude level within 0.4 dB of the 1 MHz filter.

Press the <blue-SHIFT> CAL sequence to start the calibration routine. Prompt messages on the screen will guide you through setting the four front-panel adjustments of vertical and horizontal POSITION, and AMPL and LOG CAL. This sets the absolute reference level for the 1 MHz resolution bandwidth filter. An automatic calibration is then done, which measures and corrects for absolute frequency and amplitude (relative to 1 MHz) errors of the filters. This takes approximately 60 seconds. If a message appears on the screen, refer to

Error Message Readout earlier in this section. The correction factors are held in memory. Press FINE to continue calibration as instructed or either SHIFT pushbutton to exit the routine.

FUNCTIONAL OR OPERATIONAL CHECK

This procedure uses minimum test equipment to check instrument operating modes, functions, and basic performance. The procedure checks that the instrument is operating properly. The internal calibrator and attenuator are used as the source to check most of the operational characteristics. Since both are very accurate, this check should satisfy most incoming inspection or pre-operational check-out requirements. This check will also help familiarize you with the instrument operation. A detailed Performance Check that verifies all performance requirements in the Specification section is included in the Service Manual, Volume 1.

Equipment Required

The only external equipment used is an N-male-to-bnc-female adapter and the 50 Ω coaxial cable, which are supplied as standard accessories.

Preliminary Preparation

Perform the procedure described under Preparation for Use, then allow the instrument to warm up for at least 15 minutes before proceeding with this check.

1. Check Operation of Front-Panel Pushbuttons and Controls

This procedure checks the operation of all front-panel pushbuttons and controls and ensures that the buttons illuminate when the function is active.

The LEDs light on the pushbuttons when the function is active. Lighted LEDs also indicate the allowable selections for any of the multiple function pushbuttons. For example, all DATA ENTRY pushbuttons light after <blue-SHIFT> FREQ, <blue-SHIFT> SPAN/DIV, <blue-SHIFT> REF LEVEL, or <blue-SHIFT> dB/DIV shift functions have been selected. Any lighted pushbutton can enter data for that selection. Messages are displayed on the crt as guides to the entry sequence of these selections.

Connect the CAL OUT signal to the RF INPUT with the 50 Ω cable and bnc-to-N adapter. Tune the 100 MHz, -20 dBm signal to center screen. Reduce the FREQ SPAN/DIV readout to 20 kHz, and change the VERTICAL DISPLAY to 2 dB/DIV. Press or change the following pushbuttons and controls and note their affect on the operation.

INTENSITY — Rotate the control through its range and note the crt beam brightness change.

HELP — When this mode is activated, press or operate any pushbutton and most controls to produce a help message on the crt that explains the function of that pushbutton or control. Help messages explain any error message that may appear. Activate this mode, press various pushbuttons, and observe the crt message for each. Press the HELP pushbutton again to cancel. To get HELP messages for shifted functions, press the desired SHIFT pushbutton, press HELP, then press the desired pushbutton.

GRAT ILLUM — When activated, the graticule is illuminated.

MARKER MENU — Press this pushbutton to display a menu of available marker commands that are not permanently assigned to a front-panel pushbutton.

TRIGGERING — To activate the triggering mode, press one of four pushbuttons. The pushbutton illuminates when in the active state. Press any one of the pushbuttons to cancel or deactivate any other mode. Turn VIEW A and VIEW B off to better observe the triggering effect.

FREE RUN — In the active state, the trace free runs.

INT — When active, the sweep is triggered when the signal or noise level at the left edge is ≥ 2.0 division.

(a) Tune one of the 100 MHz calibrator signals to the center of the display and adjust the REFERENCE LEVEL control so the amplitude of the signal is 2 or more divisions.

(b) Activate INT TRIGGERING to trigger the sweep.

(c) Activate FREE RUN, and set the VERTICAL DISPLAY to 2 dB/DIV so the amplitude at the left edge is less than 1 division.

(d) Reactivate INT TRIGGERING. The sweep is no longer triggered.

LINE — When active, the trace is triggered at power line frequency. Switch to LINE and the sweep will be triggered.

EXT — When this function is active, the trace runs only when an external signal ≥ 1.0 V peak is applied to the back-panel EXT IN connector. Since external test equipment is required to check this function, a check cannot be made with this procedure.

SINGLE SWEEP — When this function is active, single sweep aborts the current sweep. Press the pushbutton again to arm the sweep generator and light the READY indicator. When triggering conditions are met after the circuit is armed, the analyzer makes only one sweep. The indicator will remain lit until the sweep has run. The single sweep mode is cancelled when any TRIGGERING pushbutton is pressed. The effect of SINGLE SWEEP is more apparent with VIEW A and VIEW B off.

(a) Press FREE RUN TRIGGERING, and set TIME/DIV to 0.5 s.

(b) Press SINGLE SWEEP to abort the sweep.

(c) Press SINGLE SWEEP again, and the READY indicator lights and the sweep runs.

(d) Press FREE RUN to cancel single sweep; return TIME/DIV to AUTO.

TIME/DIV — This control selects sweep rate, manual scan, and external sweep operation. In the MNL position, the MANUAL SCAN control should move the crt beam across the horizontal axis of the crt graticule. In the EXT position, a voltage of 0 to +10 V, applied to the rear-panel HORIZTRIG connector, should deflect the crt beam across the full 10 division screen.

VERTICAL DISPLAY — Display modes are activated by three pushbuttons. Press any of these pushbuttons to cancel any other mode. Turn VIEW A and VIEW B on.

10 dB/DIV — When this pushbutton is activated, the display is a calibrated 10 dB/division with an 80 dB dynamic range.

(a) With a REF LEVEL readout of -20 dBm, activate 10 dB/DIV. Set the FREQ SPAN/DIV to 20 kHz and tune the calibrator signal to center screen.

(b) Change REF LEVEL, and the display steps in 1 division increments, representing 10 dB/division. Return the REF LEVEL readout to -20 dBm.

2 dB/DIV — When this pushbutton is pressed, the display is a calibrated 2 dB/division with 16 dB of dynamic range.

(a) Activate 2 dB/DIV, and change the REF LEVEL readout to -6 dBm. The display now steps 1.0 division for each two steps of the REFERENCE LEVEL control.

(b) Return the REF LEVEL readout to -20 dBm.

LIN — When this pushbutton is pressed, the display is linear between the reference level (top of the graticule) and zero volts (bottom of the graticule), and the crt VERTICAL DISPLAY reads out in volts/division.

Activate LIN, and the Vertical Display readout changes to mV/division.

PULSE STRETCHER — When this pushbutton is pressed, the fall-time of video signals increases so narrow video pulses will show on the display.

(a) Increase the FREQ SPAN/DIV readout to 100 MHz, change the VERTICAL DISPLAY to 10 dB/DIV, increase TIME/DIV to 1 ms, and switch VIEW A and VIEW B both off.

(b) The markers should increase in brightness when PULSE STRETCHER is activated.

(c) Turn the PULSE STRETCHER off, return TIME/DIV to AUTO, and turn both VIEW A and VIEW B on.

VIDEO FILTER — Two filters can be independently selected to provide WIDE or NARROW (approximately 1/30th or 1/300th of the resolution bandwidth) filtering to reduce noise.

(a) Change the FREQ SPAN/DIV readout to 500 kHz, and tune the calibrator signal to center screen.

(b) Alternately activate WIDE and NARROW Video Filters. The noise is reduced as the filter is switched in (see Figure 5-3). The NARROW filter will have a more pronounced effect on noise reduction. Note the change in sweep rate when the TIME/DIV selector is in the AUTO position, when the Digital Storage is off.

(c) Turn both Video Filters off.

DIGITAL STORAGE — Select either one or both of the A and B waveforms from digital storage. The amplitude of a signal should remain constant when digital storage is turned on (VIEW A or VIEW B activated). The PEAK/AVERAGE control positions a cursor over the vertical window of the screen, with noise and signal level averaged below the cursor and peak-detected above the cursor.

VIEW A — When this pushbutton is pressed, the A waveform from digital storage is displayed. With **SAVE A** off, the A waveform is updated each sweep as the beam travels from left to right. With **SAVE A** on, the waveform is not updated.

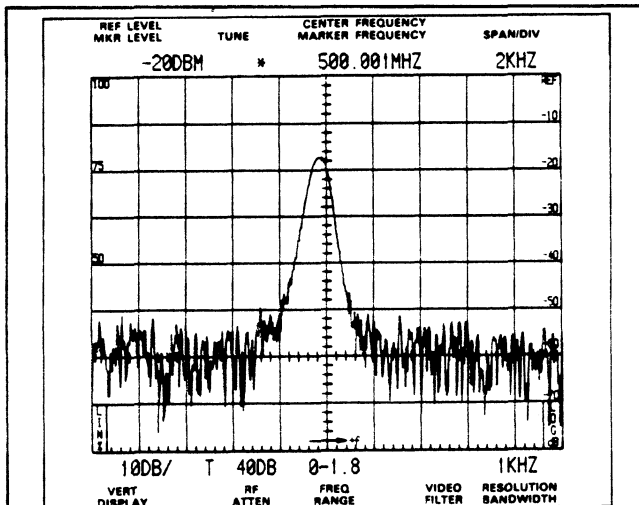

A. Spuri and IM obscured in the noise.

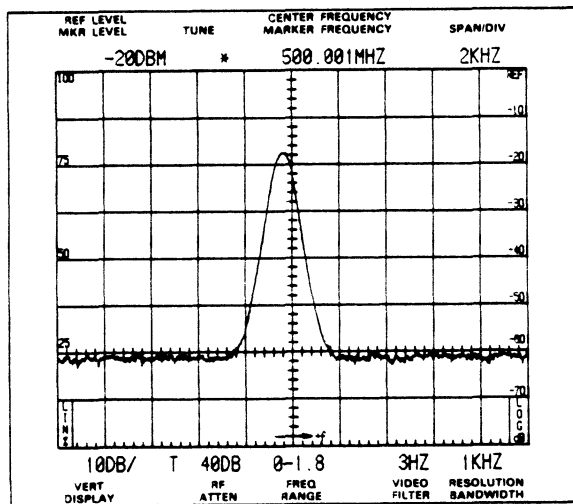

B. Same display with Video Filter activated.

5562-16

Figure 5-3. Integrating a display with the VIDEO FILTER.

VIEW B — When this pushbutton is pressed, the B waveform is displayed. When both **VIEW A** and **VIEW B** are active, the A and B waveforms are interlaced and displayed. Both waveforms are updated each sweep. Update of the A waveform depends on the state of **SAVE A**.

SAVE A — When **SAVE A** is activated, the A waveform with its readout is saved. In this mode, the data for the A waveform is not updated each sweep. Turn **VIEW B** off, and change the setting of the **REFERENCE LEVEL** control. The A display will not change. The readout for the saved waveform will be displayed any time **SAVE A** is on and **VIEW B** and **B-SAVE A** are off. If either **VIEW B** or **B-SAVE A** is on, the readout reflects the current analyzer setup.

MAX HOLD — When this pushbutton is pressed, the maximum signal amplitude at each memory location is stored. The waveform is updated only when signal data is greater than that previously stored. To verify operation, change the settings of the **CENTER/MARKER FREQUENCY** or **REFERENCE LEVEL** controls; the maximum level at each location will be retained.

B-SAVE A — Press this pushbutton to display the arithmetic difference between an updated B waveform and a **SAVE A** waveform. The **SAVE A** function is automatically activated when **B-SAVE A** is pressed.

Press **B-SAVE A**, and change the **REFERENCE LEVEL** setting so the difference between the B and **SAVE A** waveform is displayed with **VIEW A** and **VIEW B** off. The reference (zero difference) level is factory set at graticule center. The position of this reference level can be changed by qualified service personnel. Positive differences between the two displays appear above this line and negative differences below the line.

PEAK/AVERAGE — When digital storage is on, this control positions a horizontal line, or cursor, anywhere within the graticule window. Signals above the cursor are peak detected, signals below the cursor are averaged by the digital storage. To verify operation, move the cursor within the noise level; the noise amplitude will change as the cursor is positioned.

IDENTify — When the identify function is activated, every other sweep with its waveform is vertically displaced from the other. The frequencies of the 1st and 2nd local oscillators are moved so that true signals are not displaced horizontally on alternate sweeps while spurious signals are shifted significantly, or off screen. The **FREQUENCY SPAN/DIV** setting must be 50 kHz or less for the coaxial bands and 50 MHz or less for the waveguide bands (21 GHz or more) before the processor will activate the Identify mode. Refer to Using the Signal Identifier under General Operating Information, in Section 6 of this manual.

(a) With the 500 MHz calibrator harmonic tuned to center frequency, decrease the **FREQUENCY SPAN/DIV** setting to 50 kHz or less and press **IDENT**.

(b) There will be no horizontal displacement of the 500 MHz signal on alternate sweeps. To help determine if the signal is true or spurious (see Figure 5-4), decrease the sweep rate or push SAVE A with both VIEW A and VIEW B on, so a comparison can be made.

(c) Turn IDENT off.

AUTO RESOLN — When this pushbutton is pressed and FREQUENCY SPAN/DIV and TIME/DIV settings are changed, resolution bandwidth is automatically selected by the processor to maintain a calibrated display. To check operation, change FREQUENCY SPAN/DIV or TIME/DIV settings; the RESOLUTION BANDWIDTH will change. The UNCAL indicator should not light over the FREQUENCY SPAN/DIV range if the TIME/DIV selector is in the AUTO position.

MAX SPAN — When activated, the span switches to maximum and the analyzer sweeps the full band. When deactivated, the Span/Div returns to its previous setting.

ZERO SPAN — When activated, the span shifts to zero for a time-domain display. When deactivated, the span returns to its previous setting.

FREQUENCY SPAN/DIV — As this control is rotated, the Span/Div changes between 0 and Max, and the display indicates the change. The range of selections depends on the frequency band (see specifications in Section 2).

RESOLUTION BANDWIDTH — As this control is rotated from a full counterclockwise position, the resolution bandwidth changes in decade steps from 30 Hz to 1 MHz.

REFERENCE LEVEL — With 10 dB/DIV VERTICAL DISPLAY active and FINE off, the REF LEVEL readout steps in 10 dB increments as the control is rotated. When FINE is activated, the steps are 1 dB. In the 2 dB/DIV mode, the steps are 1 dB with FINE off and 0.25 dB with FINE active. When the Vertical Display factor is 4 dB/div or less with FINE on, the analyzer switches to the delta A mode. In the delta A mode, the REF LEVEL readout goes to 0.00 dB, then steps in 0.25 dB increments as the REFERENCE LEVEL control is rotated.

(a) Set the MIN RF ATTN dB control to 0 dB and VERTICAL DISPLAY to 10 dB/DIV. Rotate the REFERENCE LEVEL control counterclockwise to 30 dBm, then clockwise to -110 dBm.

(b) The REF LEVEL readout changes in 10 dB increments.

(c) Press FINE, and change the setting of the REFERENCE LEVEL control. The REF LEVEL readout now steps in 1 dB increments.

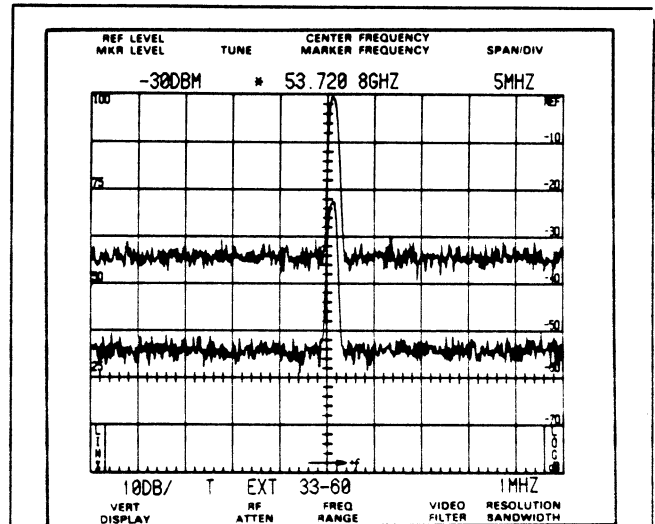

A. Typical response of a true or real signal.

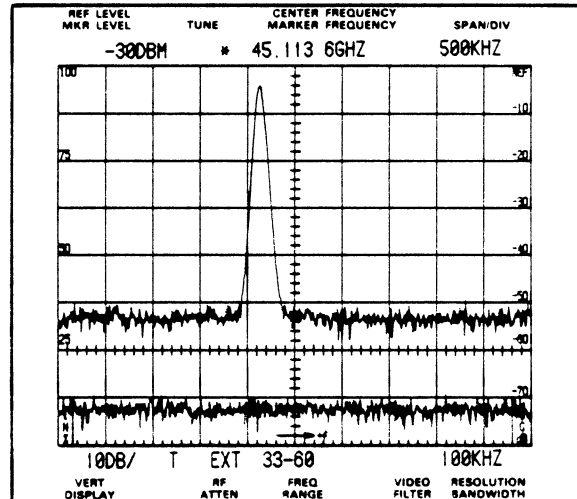

B. Typical response from a false signal. Signal for bottom sweep is off screen.

5562-17

Figure 5-4. Using the IDENT feature to identify a real or true response.

(d) Press <blue-SHIFT> dB/DIV and 4 dB with the DATA ENTRY pushbuttons, and the REF LEVEL readout goes to 0.00 dB. Rotate the REFERENCE LEVEL control. The REF LEVEL now steps in 0.25 dB increments from the 0.00 dB reference.

(e) Return the REF LEVEL readout to -20 dBm, and 10 dB of RF ATTENUATION is switched in.

MIN RF ATTEN dB — This control sets the minimum amount of RF attenuation in the signal path, regardless of the REFERENCE LEVEL control setting. To check operation, set the MIN RF ATTEN dB selector to 20 and change the REFERENCE LEVEL control settings. The RF ATTENUATION readout will not go below 20 dB.

FINE — When activated, the REFERENCE LEVEL control steps decrease. (Refer to the REFERENCE LEVEL check earlier in this section).

MIN NOISE/MIN DISTORTION — This pushbutton selects one of two methods that select RF attenuator and IF gain. MIN NOISE (button illuminated) reduces the noise level by reducing attenuation 10 dB and decreasing IF gain 10 dB. MIN DISTORTION reduces IM distortion due to input mixer overload. The normal mode of operation is with minimum distortion. To observe any change, the amount of RF ATTENUATION displayed by the crt readout must be 10 dB higher than the MIN RF ATTEN dB selector setting.

(a) Set the FREQUENCY readout to 100 MHz, FREQ SPAN/DIV to 500 kHz, REF LEVEL readout to -20 dBm and MIN RF ATTEN dB to 0 dB. The RF ATTENUATION readout will indicate 10 dB.

(b) Activate MIN NOISE. The noise floor will drop approximately 10 dB, and the RF ATTENUATION readout will change to 0 dB.

(c) Deactivate MIN NOISE.

UNCAL — This indicator lights when the display is uncalibrated.

(a) Set the TIME/DIV control to 50 ms, deactivate AUTO RESOLUTION, and set RESOLUTION BANDWIDTH to 10 kHz.

(b) The UNCAL indicator should light and remain lit until the FREQ SPAN/DIV readout is reduced to 100 kHz or the RESOLUTION BANDWIDTH is increased to 100 kHz.

(c) Return TIME/DIV control to AUTO, press AUTO RESOLUTION, and set the FREQUENCY SPAN/DIV control to 100 MHz.

SHIFT — These pushbuttons shift multiple-function pushbuttons to their alternate function. The names of most of these alternate functions are printed in blue or green lettering next to the pushbutton. The shift mode deactivates after the function has been performed.

DATA ENTRY pushbuttons for the shift mode are labeled with orange lettering.

RECALL SETTINGS/STORE — When this pushbutton is pressed, the processor lists the settings, with their center frequency, that are stored in memory (registers 0-9). The 0 register holds the power-down settings so they can be recalled after power-up. Press <blue-SHIFT> STORE to store the existing front-panel

setup in one of the available registers.

(a) Press <blue-SHIFT> STORE, and select register number 1 with the DATA ENTRY push-buttons to store the current front-panel setup.

(b) Change front-panel pushbutton and control settings.

(c) Press RECALL SETTINGS, then DATA ENTRY 1 to recall the setup.

(d) The instrument front-panel set-up returns to that previously entered, with the exception of the Time/Div and RF Attenuation setting.

ΔF — When the delta F function is activated, FREQUENCY readout initializes to 0. The frequency difference, to a desired signal or point on the display, can be determined by tuning that point to center screen and noting the readout. Check by measuring the difference between calibrator harmonics. If the delta frequency is tuned below 0, the readout will include a minus sign.

TUNE CF/MARKER — When this pushbutton is lit, a marker appears as a bright spot on the screen and the CENTER/MARKER FREQUENCY control tunes the marker; the FREQUENCY readout remains constant. An asterisk (*) between the FREQUENCY and REF LEVEL readout indicates that the CENTER/MARKER FREQUENCY control is tuning the Marker Frequency. The marker level and marker frequency appear on the second readout line on the crt.

+STEP/-STEP — When these pushbuttons are pressed, the marker or center frequency is increased or decreased by steps. Perform the following steps while in the Tune CF mode.

(a) Reduce the SPAN/DIV readout to 50 MHz, set the FREQUENCY readout to 100MHz. Press <blue-SHIFT> STEP ENTRY; enter 25 MHz with the DATA ENTRY pushbuttons. Press +STEP, the FREQUENCY readout will increase to 125 MHz. Press +STEP again, and the FREQUENCY readout will increase to 150 MHz.

(b) Push the -STEP pushbutton. The FREQUENCY readout will decrease to 125 MHz, and push -STEP again to return the FREQUENCY readout to 100 MHz.

RESET TO LOCAL — (495P Instruments Only) The RESET TO LOCAL pushbutton is lighted when the spectrum analyzer is under control of a GPIB controller. While under remote control, the other front-panel controls are not active, but indicators will still reflect the current state of all front-panel functions, except Time/Div, Peak/Average and RF Attenuation.

This pushbutton is not lighted when the spectrum analyzer is under local operator control. While under local control, the spectrum analyzer does not execute GPIB messages that would conflict with front-panel con-

trols or change the waveforms in digital storage.

When the pushbutton is pressed, local control is restored to the operator unless the controller prevents this with the local lockout message. Programmable functions do not change when switching from remote to local control, except as necessary to match the settings of front-panel controls for TIME/DIV, MIN RF ATTEN dB, and PEAK/AVERAGE.

The internal instrument and front-panel firmware version numbers and the GPIB address are flashed on the crt when the pushbutton is pressed. The GPIB primary address is updated if the GPIB ADDRESS switches have been changed.

For another function of this pushbutton when in the talk-only mode, refer to Talk-Only/Listen-Only Operation in Section 6 of this manual.

GPIB Function Readout — (495P Instruments Only) A single character appears in the lower crt readout when the spectrum analyzer is talking (T), listening (L), or requesting service (S). Two characters will appear in this location if the spectrum analyzer is talking or listening and also requesting service, or is in the talk/listen mode.

DATA ENTRY — Some functions require a parameter or command to be entered that includes numerical data. This data is entered with the DATA ENTRY pushbuttons.

(a) Set the **FREQ SPAN/DIV** readout to 50 kHz and turn **AUTO RESOLUTION** on. Set the **FREQUENCY** readout to 2.0 GHz by pressing <blue-SHIFT> **FREQ 2 GHz** with the **DATA ENTRY** pushbuttons. This sets the **FREQUENCY** to 2.000 GHz. (The number of digits is a function of the span/div that was previously entered.)

(b) Enter frequencies of 200 MHz and 200 kHz by repeating the procedure in step a. The **FREQUENCY** readout will be set to the figures entered with the **DATA ENTRY** pushbuttons.

(c) With the **DATA ENTRY** pushbuttons, set the **SPAN/DIV** readout to any desired setting. The **SPAN/DIV** readout will be set to the figures entered with the **DATA ENTRY** pushbuttons (rounded to 2 digits).

(d) Enter a reference level with the **DATA ENTRY** pushbuttons. The **REF LEVEL** readout will be set to the figures entered with the **DATA ENTRY** pushbuttons.

(e) Enter a desired vertical display factor with the **DATA ENTRY** pushbuttons. The **VERTICAL DISPLAY** readout will be set to the figures entered with the **DATA ENTRY** pushbuttons (rounded to 2 digits).

STORE DISPlay — Press <blue-SHIFT> **STORE DISP**, the register number where you want to store the display, and the display (A or B) you want stored (only if **SAVE A** is on).

RECALL — Press <blue-SHIFT> **RECALL**, the register number from the displayed menu, and the part of digital storage (A or B) where you want to have the recalled waveform placed.

SAVE A is automatically activated to prevent an overwrite. If **A** is selected, **VIEW A** must be on to observe the recalled waveform and **VIEW B** must be off to see the readout that applies to the recalled waveform. If **VIEW B** and **VIEW A** are on, both the recalled waveform in **A** and the current waveform in **B** will be displayed. Readout will apply to the current **B** waveform.

If **B** is selected, the next sweep will overwrite the display unless **SINGLE SWEEP** was activated before selecting **B**; a message will appear on the screen as a reminder of this. **VIEW B** must be on to observe the recalled waveform and its readout. Remember to deactivate **SINGLE SWEEP** when leaving this recalled mode.

(a) Establish a display on the screen. Press <blue-SHIFT> **STORE DISPlay**, the memory register number (0–8) to place the display, and the display (A or B) you wish stored (only if **SAVE A** is on).

(b) Change the characteristics of the current display with either **REFERENCE LEVEL** or **FREQUENCY SPAN/DIV** control.

(c) Press <blue-SHIFT> **RECALL**, the register number where the display was stored (note the center frequency listing of the stored displays in each register), then **VIEW A** so the recalled waveform is placed in the **A** part of digital storage.

(d) If **VIEW A** is on and **VIEW B** off, the recalled display with its readout will now become the **A** display. **SAVE A** will activate to prevent overwrite. If **VIEW A** and **VIEW B** are on, both the recalled display and the current **B** display will be on screen. Since the most current display is the **B** waveform, the readout will show the parameters for the **B** display. Switch **VIEW B** off to see the readout applicable to the recalled **A** waveform.

(e) Recall a stored display into the **B** section by repeating the process in step d. Before starting the process, press **SINGLE SWEEP** so the recalled waveform will not be overwritten by the next sweep; a message will appear when you select the **B** section to remind you of this. When returning to normal operation, remember to deactivate **SINGLE SWEEP** if you have not already done so.

NOTE

If an attempt is made to recall a display from an empty location, error message NON-VOLATILE RAM will be displayed.

MKR OFF — Press <blue-SHIFT> MKR OFF to turn off the markers.

MKR → CENTER — Press <blue-SHIFT> MKR → CENTER to bring a marker signal to center screen.

(a) Set the REF LEVEL readout to -20 dBm, FREQUENCY readout to 100 MHz. Set FREQ SPAN/DIV to 200 kHz, and VERTICAL DISPLAY to 10 dB/DIV; set RESOLUTION BANDWIDTH to 100 kHz.

(b) Tune the signal off center, activate TUNE MKR. Tune the Marker to the top of the signal and press <blue-SHIFT> MKR → CENTER. The signal should move to center screen.

READOUT — Press <blue-SHIFT> READOUT to turn off the crt readout of the REF LEVEL, FREQUENCY, SPAN/DIV, VERTICAL DISPLAY, RF ATTENUATION, FREQ RANGE, RESOLUTION BANDWIDTH, VIDEO FILTERS, MKR LEVEL, and MARKER FREQUENCY. Press <blue-SHIFT> READOUT to reactivate the readout on the display.

FREQ START STOP — Activating <blue-SHIFT> FREQ START STOP allows you to enter a start and stop frequency with the DATA ENTRY pushbuttons.

(a) Enter a start frequency of FREQ 90 MHz with the DATA ENTRY pushbuttons. Enter stop frequency 210 MHz.

(b) The signals at the 1st and 9th graticule line should be 100 MHz apart. Set the VERTICAL DISPLAY to 10 dB/DIV, and observe that the SPAN/DIV readout is 12 MHz.

STEP ENTRY — Activate <blue-SHIFT> STEP ENTRY to set the step to a desired amount. Perform the following steps while in the Tune Marker mode.

Press <blue-SHIFT> STEP ENTRY and enter a step frequency of 10 MHz. Activate +STEP and note that the MARKER FREQUENCY readout is 160 MHz. Push -STEP to return the MARKER FREQUENCY setting to 150 MHz. Turn off the marker by pressing <blue-SHIFT> MKR OFF.

BASELINE CLIP — Press <blue-SHIFT> BASELINE CLIP to clip (blank) the baseline of the display up to about one graticule division.

RESET — Press <blue-SHIFT> RESET to return the instrument to the original power-up state.

REF LEVEL UNITS — Change the REF LEVEL readout to 0 dBm. Press <blue-SHIFT> REF LEVEL UNITS. Select item 1, and note the REF LEVEL readout change to -13 dBV. Select item 2, and note the REF LEVEL readout change to 47 dBmV. Select item 3, and note the REF LEVEL readout change to 107 dBμV. Press 0 to return the readout to 0 dBm.

Green-SHIFT Functions — Press green-SHIFT to change the pushbuttons that have more than one function. Some functions require a parameter or command to be entered that includes numerical data. This data is entered with the DATA ENTRY pushbuttons. Most green-shifted functions are marker related.

Markers — The markers provide direct readout of frequency and amplitude information of any point along any displayed trace or relative (delta frequency) and amplitude information between any two points along any displayed trace or traces (in delta only). In the delta mode, only the difference in frequency and amplitude will be displayed. Two independent marker frequencies and amplitudes cannot be displayed at the same time.

With the CENTER FREQUENCY readout at 100 MHz, a REF LEVEL readout of -10 dBm, and a FREQ SPAN/DIV of 5 MHz, press TUNE CF/MARKER. A bright dot, the marker, appears on screen, as well as a second line of readout with an asterisk between the MKR LEVEL and MARKER FREQUENCY readout. Turn the CENTER/MARKER FREQUENCY knob, and note that the marker tunes.

Press TUNE CF/MARKER again, the indicator button will not be lit but the marker remains on screen. When the CENTER/MARKER FREQUENCY knob is rotated now, the marker does not move, but both the Center Frequency and the Marker Frequency change. Also, the asterisk has now moved to the first readout line to indicate that the center frequency is being tuned.

Return the FREQUENCY readout to 100 MHz, and press TUNE CF/MARKER to activate the marker.

PEAK FIND — Press <green-SHIFT> PEAK FIND to move the marker to the top of the signal.

Δ MKR, 1—MKR—2, MKR START STOP, MKR → REF LEVEL, ASSIGN 1, ASSIGN 2 — Press <green-SHIFT> Δ MKR to activate a second marker at the position of the single marker on the trace. Parentheses will be added to the second line readout.

(a) Rotate the CENTER/MARKER FREQUENCY control; two markers will be on screen. Set the delta marker readout to 5 MHz.

(b) Press <green-SHIFT> 1→MKR→2. The left marker is now brighter as an indication that it is being tuned. Tune the marker until the readout shows -10 MHz, which is the difference in frequency between the two markers (the delta marker frequency).

(c) Press <green-SHIFT> MKR START STOP. The markers now appear at the left and right edge of the screen. The waveform will be "zoomed in".

(d) Press <green-SHIFT> Δ MKR again, there will be just a single marker now, and the parentheses around the second line of readout will disappear.

(e) Press <green-SHIFT> PEAK FIND, then <blue-SHIFT> MKR→CENTER. The signal is now at center screen.

(f) Press <green-SHIFT> MKR→REF LEVEL, the signal and the marker will now be at the top of the screen.

(g) Reduce the FREQ SPAN/DIV readout to 500 kHz, and set the RESOLUTION BANDWIDTH to 1 MHz.

(h) Press MARKER MENU. Nine menu items are displayed. Press 7, and you will be prompted to enter the bandwidth number. Enter 10 dB with the DATA ENTRY pushbuttons, press <green-SHIFT> BANDWIDTH MODE, and observe that the Delta MKRs have moved down 10 dB from the top of the signal. Delta frequency is a little over 1 MHz wide. Press <green-SHIFT> BANDWIDTH MODE again to turn it off.

(i) Press <blue-SHIFT> MKR OFF, and using the DATA ENTRY pushbuttons, set the FREQUENCY readout to 200 MHz and the FREQ SPAN/DIV readout to 25 MHz. Set the Peak/Average cursor to the bottom of the screen. Press TUNE CF/MKR.

(j) Press <green-SHIFT> PEAK FIND. The marker will now be positioned on the 100 MHz calibrator signal (the left-most tall signal of the three signals on screen).

(k) Press MARKER MENU. Nine menu items are displayed. Press 6 and the Assign Menu is displayed with seven menu items. Press 3 and note that both ASSIGN pushbuttons light. Press <green-SHIFT> ASSIGN 1 to assign the Next Lower Peak function.

(l) Press MARKER MENU again. Press 6 to get the Assign Menu. Press 2. Press <green-SHIFT> ASSIGN 2 to assign the Next Higher Peak function.

(m) Press <green-SHIFT> ASSIGN 2. The marker will move to the 300 MHz calibrator harmonic. Press the <green-SHIFT> ASSIGN 2

pushbutton one more time; the marker will move to the 200 MHz calibrator harmonic. Press <green-SHIFT> ASSIGN 1 twice to return the marker to the original 100 MHz signal. Press TUNE CF/MKR to turn the marker off.

SIGNAL TRACK — Press the <green-SHIFT> SIGNAL TRACK sequence to keep a drifting signal on screen.

(a) Set the REF LEVEL readout to -20 dBm, the FREQUENCY readout to 100.000 MHz, the SPAN/DIV readout to 5 kHz. Set the RESOLUTION BANDWIDTH to 1 kHz, and tune the signal off center. The signal should be on screen.

(b) Press the <green-SHIFT> SIGNAL TRACK sequence. The TUNE MKR lights and the signal will be moved back to center screen. Signal Track will be indicated in the marker readout on the crt.

(c) To deactivate the function, press <green-SHIFT> SIGNAL TRACK again.

2. Check Gain Variation Between Resolution Bandwidths

(less than 0.4 dB with respect to the 1 MHz filter and less than 0.8 dB between any two filters)

a. Calibrate the Center/Marker Frequency, Reference Level, and Bandwidth as described earlier in this section.

b. Set the FREQUENCY readout to 100 MHz by pressing <blue-SHIFT> FREQ 1 0 0 MHz with the DATA ENTRY pushbuttons. Set the FREQUENCY SPAN/DIV control to 1 MHz, the RESOLUTION BANDWIDTH to 1 MHz, the REFERENCE LEVEL control to -20dBm, TIME/DIV to AUTO, and activate AUTO RESOLUTION.

c. Apply 100 MHz markers from the CAL OUT connector to the RF INPUT. Set the Vertical Display factor to 1 dB/DIV by pressing <blue-SHIFT> dB/DIV 1 dB, and set the RESOLUTION BANDWIDTH readout to 1 MHz.

d. Verify that the amplitude of the 100 MHz signal is at the top graticule line. If not, repeat the front-panel calibration procedure by pressing <blue-SHIFT> CAL.

e. Change the REF LEVEL readout to -19 dBm, RESOLUTION to 1 MHz and activate SAVE A. This is the reference for checking the other filters.

f. Change the RESOLUTION BANDWIDTH and FREQUENCY SPAN/DIV controls to 100 kHz.

g. Check the amplitude of the 100 MHz signal. It should be within 0.4 dB of the 1 MHz reference established in part e.

h. Set the RESOLUTION BANDWIDTH control to each of the remaining positions and the FREQ SPAN/DIV readout for a readable display. The amplitude accuracy and frequency can now be checked with respect to the 1 MHz reference and between any two filters. Reference

level error should not exceed 0.4 dB from the reference and 0.8 dB between any filter.

- i. Turn SAVE A off.

3. Check Span Accuracy and Linearity

Span accuracy is the displacement error of calibrator markers from the center reference over ± 4 major divisions of span. Linearity accuracy is determined by the displacement of calibrator frequency markers from their specified positions over the center eight divisions of the display area, using the 1st graticule line as the reference.

a. Set the FREQUENCY readout to 500 MHz, the FREQUENCY SPAN/DIV control to 100 MHz, the REF LEVEL readout to -20 dBm, and activate AUTO RESOLUTION. Change the VERTICAL DISPLAY to 10 dB/DIV.

b. Span is accurate when the 100 MHz lines are within 5% of their reference graticule line over the center eight divisions. (It may be easier to observe the lines with DIGITAL STORAGE off.)

c. Tune CENTER/MARKER FREQUENCY to align one of the lines at the 1st graticule line from the left edge.

d. Linearity is accurate when the displacement of successive lines, over the center eight divisions, does not exceed 5% of 100 MHz (the FREQ SPAN/DIV setting) or 0.2 division.

4. Check Resolution Bandwidth and Shape Factor

(bandwidth is within 20% of the selected 1 MHz to 100 Hz range, in decade steps to 100 Hz; shape factor is 7.5:1 or less)

a. With the Calibrator output applied to the RF INPUT and the FREQUENCY readout at 100 MHz, set the REFERENCE LEVEL control to -20 dBm, the FREQ SPAN/DIV control to 500 kHz, RESOLUTION BANDWIDTH to 1 MHz, TIME/DIV at AUTO, VERTICAL DISPLAY to 2 dB/DIV, and activate MIN NOISE.

b. Measure the 6 dB down bandwidth (see Figure 5-5A). Bandwidth should equal 1 MHz, ± 200 kHz.

c. Change VERTICAL DISPLAY to 10 dB/DIV, and measure the 60 dB down bandwidth (see Figure 5-5B).

d. Calculate the shape factor as the ratio of -60 dB/-6 dB bandwidths (see Figure 5-5). Shape factor should equal 7.5:1 or less.

e. Change the RESOLUTION BANDWIDTH setting to 100 kHz and the FREQ SPAN/DIV to 100 kHz.

f. Check the resolution bandwidth and shape factor of the 100 kHz filter by repeating the above process.

g. Repeat the process to check the resolution bandwidth and shape factor for the 10 kHz, 1 kHz, 100 Hz, and 30 Hz filters. Shape factor should equal 12:1 for the 30 Hz filter and 7.5:1 for the rest.

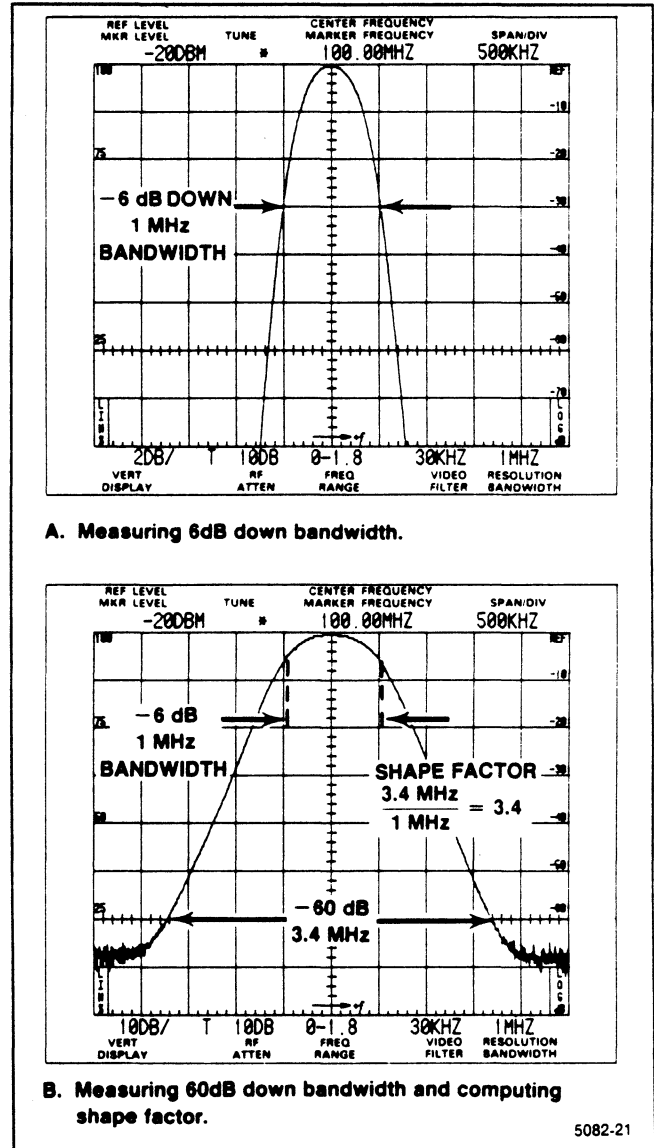

Figure 5-5. Displays that illustrate how bandwidth and shape factor are determined.

5. Check Reference Level Gain and RF Attenuator Steps

a. With the Calibrator signal applied to the RF INPUT and the FREQUENCY readout set to 100 MHz, set the FREQ SPAN/DIV and RESOLUTION BANDWIDTH controls to 100 kHz. Set VERTICAL DISPLAY to 10 dB/DIV, REF LEVEL readout to -20 dBm, and activate MIN NOISE and NARROW VIDEO FILTER.

b. To check the attenuator, increase REF LEVEL readout to +40 dBm; the signal peak will decrease 1 major division per 10 dB step of the RF ATTENUATION.

c. Set FREQUENCY readout to 200 MHz and the REFERENCE LEVEL control to -20 dBm.

d. Increase the MIN RF ATTEN dB to 60 dB; the noise level will increase 1 division for each 10 dB step.

e. To check IF gain steps, switch the REFERENCE LEVEL control between -20 dBm and +40 dBm. The noise level will decrease 1 division per step.

f. Activate FINE; then, check that the trace rises 1 dB/step of the reference level as it is changed to +30 dBm.

g. Switch FINE off, and reduce MIN RF ATTEN setting to 0.

h. Switch MIN NOISE off; the noise floor will rise about 1 division as the RF ATTENUATION increases 10 dB. REF LEVEL readout should not change.

i. Change REF LEVEL to -60 dBm, and switch VERTICAL DISPLAY to 2 dB/DIV. Adjust REF LEVEL so the signal level is near the top graticule line.

j. Change the REFERENCE LEVEL control; the signal amplitude will change in 1 dB increments (0.5 div).

k. Set VERTICAL DISPLAY readout to 1 dB/DIV with the <blue-SHIFT> dB/DIV 1 dB with the DATA ENTRY pushbuttons.

l. Change the REFERENCE LEVEL control positions; the REF LEVEL readout will change in 1 dB steps, and the display in 1 division steps.

m. Activate FINE (Delta A mode). The REF LEVEL now reads 0.00 dB, which denotes the Delta A mode.

n. Change the REFERENCE LEVEL control positions; the REF LEVEL readout will change in + or - 0.25 dB increments.

o. Deactivate FINE. Change the VERTICAL DISPLAY to 10 dB/DIV and the REF LEVEL readout to -20 dBm.

6. Check Sensitivity (refer to Table 5-1)

NOTE

Sensitivity is specified according to the input mixer average noise level. The calibrator signal is the reference used to calibrate the display.

a. Remove the calibrator signal from the RF INPUT. Set VERTICAL DISPLAY to 10 dB/DIV, REF LEVEL readout to -30 dBm, FREQ SPAN/DIV readout to 5 MHz, the RESOLUTION BANDWIDTH control to 1 MHz, the TIME/DIV control at 1 second. Adjust the PEAK/AVERAGE cursor so it is off the top of the screen, and activate the WIDE VIDEO FILTER.

b. The noise floor (level) should be as specified in Table 5-1.

c. Change the REFERENCE LEVEL control to -40 dBm, the FREQUENCY SPAN/DIV control to 1 MHz, and the RESOLUTION BANDWIDTH control to 100 kHz.

d. The noise floor should be at least -103 dBm (refer to Table 5-1).

**Table 5-1
SENSITIVITY**

Resolution Bandwidth	Equivalent Input Noise
30 Hz	-130 dBm
100 Hz	-125 dBm
1 KHZ	-115 dBm
10 kHz	-105 dBm
100 kHz	-95 dBm
1 MHz	-85 dBm

e. Change the REFERENCE LEVEL control to -60 dBm, the FREQUENCY SPAN/DIV to 10 kHz, the TIME/DIV control to AUTO and the RESOLUTION BANDWIDTH control to 1 kHz.

f. Check that the average noise level for the 1 kHz resolution bandwidth is as listed in Table 5-1.

g. Change REFERENCE LEVEL control to -70 dBm, the FREQUENCY SPAN/DIV control to 200 Hz, and RESOLUTION BANDWIDTH control to 100 HZ.

h. Check that the noise level for the 100 Hz resolution bandwidth is as listed in Table 5-1.

i. Repeat this procedure for the remaining input frequency range.

7. Check Residual FM

(within 7 kHz over 20 ms, with FREQ SPAN/DIV readout greater than 200 kHz, and within 12 Hz, over 20 ms, with FREQ SPAN/DIV readout of 200 kHz or less)

a. With the calibrator signal applied to the RF INPUT, set the FREQUENCY readout to 100 MHz, the FREQ SPAN/DIV readout to 1 MHz, the RESOLUTION BANDWIDTH control to 100 kHz, VERTICAL DISPLAY to 2 dB/DIV, and the REFERENCE LEVEL readout to -23 dBm.

b. Press <blue-SHIFT> 10 dB/DIV. A message will appear on the screen to indicate that the 1st LO synthesis and phase lock are disabled. This is normal. It is now possible to switch the FREQUENCY SPAN/DIV control to narrower spans with the 1st LO phase lock disabled.

c. Decrease the FREQUENCY SPAN/DIV and RESOLUTION BANDWIDTH settings to 10 kHz. Keep the 100 MHz calibrator signal centered on the screen with the CENTER/MARKER FREQUENCY control.

d. Switch the VERTICAL DISPLAY to LIN. Position the signal so the slope (horizontal versus vertical excursion) of the response can be determined (see Figure 5-6A). It may help to determine slope by using SINGLE SWEEP or SAVE A to freeze the display at a convenient point on the graticule for measurement.

e. If SINGLE SWEEP or SAVE A were used in part d, deactivate SAVE A or SINGLE SWEEP. Push ZERO SPAN, set the TIME/DIV setting to 20 ms, and adjust the CENTER/MARKER FREQUENCY control to position the display near center screen as shown in Figure 5-6B. Use SINGLE SWEEP or SAVE A to freeze the display for ease in measuring the FM (frequency modulation). The peak-to-peak amplitude of the display per any horizontal division, scaled to the vertical deflections according to the slope estimated in part d, is the residual FM. Residual FM must not exceed 7 kHz for 20 ms (1 division).

f. Press <blue-SHIFT> 10 dB/DIV to re-enable the phase lock, and set the FREQUENCY readout to 100 MHz. Switch the TIME/DIV setting to AUTO, and reduce the FREQUENCY SPAN/DIV to 200 Hz and RESOLUTION BANDWIDTH settings to 100 Hz.

g. Adjust the CENTER/MARKER FREQUENCY control to position the signal so its slope can be determined. It will be easier if you use SINGLE SWEEP or SAVE A to freeze the display at a convenient position on the graticule.

h. Deactivate SAVE A or SINGLE SWEEP, and switch the TIME/DIV control to 20 ms. Activate ZERO SPAN, and position the display near center screen so the verti-

cal excursions per horizontal division (20 ms) can be measured. Residual FM must not exceed 12 Hz.

8. Check Frequency Drift or Stability

(50 Hz or less per minute of sweep time, when the FREQ SPAN/DIV is 200 kHz or less, after 1 hour of warmup, and within a stable ambient temperature)

a. With the Calibrator signal applied to the RF INPUT, set the FREQUENCY readout to 100 MHz, the TIME/DIV control to AUTO, the FREQUENCY SPAN/DIV control to 200 Hz, the RESOLUTION BANDWIDTH control to 100 HZ, VERTICAL DISPLAY to 2 dB/DIV, and the REFERENCE LEVEL control to -23 dBm. Switch VIEW A and VIEW B on.

b. Adjust the CENTER/MARKER FREQUENCY control so one side of the signal intersects the sixth division graticule line from the left edge. Press SINGLE SWEEP, and activate SAVE A to save the display.

c. Select the NARROW VIDEO FILTER, and press SINGLE SWEEP again to start the sweep. The sweep will now run at a 10 s/div rate.

d. Note the frequency difference between the two displays at the sixth graticule line. Label this difference delta f.

e. Check that the frequency drift rate in Hz/minute = $300 \times \Delta f / (250 + \Delta f)$. Drift rate must not exceed 50 Hz/minute.

9. GPIB Verification Program

The Service Manual, Volume 1, contains a GPIB verification program. If you wish to check the operation of the GPIB interface, request the program from service personnel.

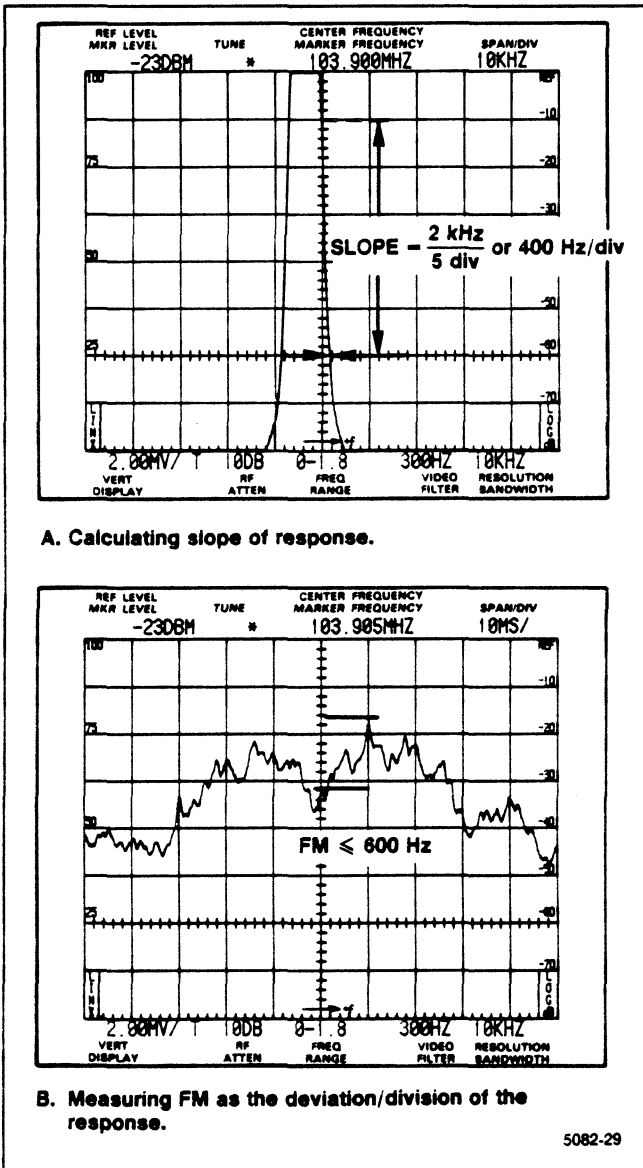

Figure 5-6. Typical display showing how to determine residual FM.

OPERATION

This section describes the normal operating features of the spectrum analyzer. Many instrument features and operating modes are described, and examples are included to show some typical applications.

INSTRUMENT OPERATING FEATURES

Firmware Version and Error Message Readout

Refer to Section 5 for information.

Crt Light Filters

Two light filters, amber and grey, are supplied as standard accessories to the spectrum analyzer. Select the filter that best suits the surrounding light conditions, light reflections, and your viewing needs. To install the filter, pull the top of the plastic mask out and place the filter behind it. Remove the light filter when taking display photographs.

Intensity Level and Beam Alignment

Operate the instrument with the intensity level no higher than that required to clearly see the display. Trace alignment and beam focus are internal adjustments that must be performed by qualified service personnel.

The required intensity level for some displays may be high enough to produce a bright and flared baseline. This bright baseline can be eliminated (clipped) with the <blue-SHIFT> BASELINE CLIP pushbutton sequence. <Blue-SHIFT> BASELINE CLIP is useful when photographing displays, and it also allows the lower readout characters to be more easily viewed. When the markers are turned on, set the intensity below the level where dot "blooming" or defocusing occurs.

Signal Application

Signal frequencies to 1.8 GHz can be applied through a short, high-quality, 50 Ω coaxial cable to the RF INPUT connector. These signals pass through an internal RF attenuator to the 1st mixer.

RF INPUT Connector

The nominal input impedance of the coaxial RF INPUT is 50 Ω , and 75 Ω on the optional 75 Ω INPUT (Option 07). Because cable losses can be significant at microwave frequencies, it is important to keep the cables as short as possible. Impedance mismatch between the signal source and the RF INPUT will produce reflections that degrade flatness, frequency response, and sensitivity and may increase spurious responses. Impedance mismatch can be caused by poor connections, incorrect signal source impedance, and long or low-quality coaxial cable. When optimum flatness or frequency response is desired and signal strength is adequate, set the MIN RF ATTEN dB control to 10 dB or more. The addition of the attenuator helps minimize reflections to improve the input characteristics.

CAUTION

The front end of the spectrum analyzer is specified at +30 dBm maximum. It is possible to set the reference level to +40 dBm with MIN NOISE activated. If the signal level is increased for a full-screen display, the input level will exceed the power rating of the attenuator. Do not apply any dc potential to the RF INPUT. Use a dc block if a signal is riding on any dc potential. For dc block ordering information, see the Optional Accessories in the Service Manual, Volume 2, or contact your local Tektronix Field Office or representative.

Spurious responses can be minimized if the signal amplitude is kept within the graticule window. A recommended procedure is to select a reference level setting that limits stronger signals to the graticule window.

High-level signals can cause compression; if excessive (above +30 dBm or +20 dBm when MIN NOISE is on), the 1st mixer attenuator may be destroyed. Signals above +30 dBm must be reduced by external attenuators. Ensure that the frequency range of any external attenuator is adequate.

Line impedance stabilizing networks, used for conducting EMI/RF measurements, will often have several volts of 60 Hz signal at the output. To protect the input mixer, use a dc block (refer to the Service Manual, Volume 2, or your local Tektronix Field Office or representative for ordering information). It is important to be sure that all equipment being tested has power applied through the line stabilizing networks before any

RF signal is connected to the spectrum analyzer input.

Connecting to a 75 Ω Source — Signals from a 75 Ω source, at the lower frequencies (1 MHz to 1 GHz), can be applied directly to the 75 Ω INPUT if Option 07 is installed or to the RF INPUT by using a 75 Ω-to-50 Ω minimum loss attenuator (refer to the Tektronix catalog or your local field office or representative for ordering information). A circuit diagram of a suitable matching pad for this purpose is shown in Figure 6-1.

Sensitivity and power levels are often rated in dBm (dB with reference to 1 mW regardless of impedance). Sensitivity and power levels for 75 Ω systems are usually rated in dBmV (dB with reference to 1 mV across 75 Ω). Figure 6-2 shows the relationship between 50 Ω and 75 Ω units with matching attenuators included. The conversion to alternate reference level units is listed below for 75 Ω and is shown in Table 6-1 for 50 Ω.

1. dBmV (75 Ω) = dBm (50 Ω) + 54.47 dB:
e.g. -60 dBm (50 Ω) + 54.47 dB = -5.5 dBmV (75 Ω).
2. dBm (75 Ω) = dBm (50 Ω) + 5.72 dB:
e.g. -60 dBm (50 Ω) + 5.72 dB = -54.3 dBm (75 Ω).

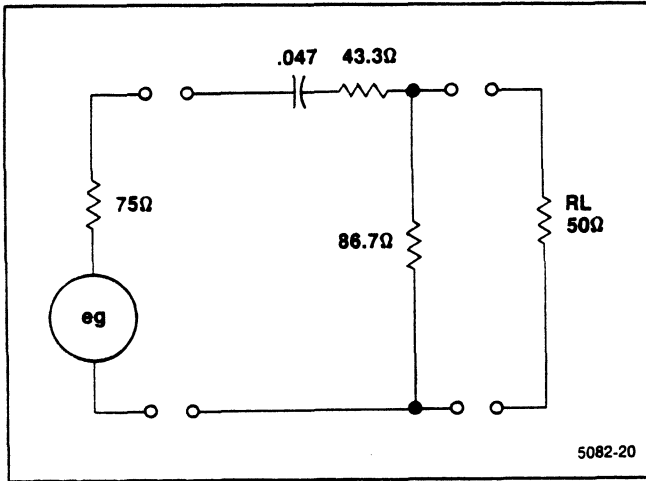

Figure 6-1. Circuit of a 75 to 50 Ω matching pad (ac coupled).

Table 6-1
50 Ω SYSTEM REFERENCE LEVEL
CONVERSION

To From	dBm	dBmV	dBμV
dBm	0	+47	+107
dBmV	-47	0	-60
dBμV	-107	+60	0

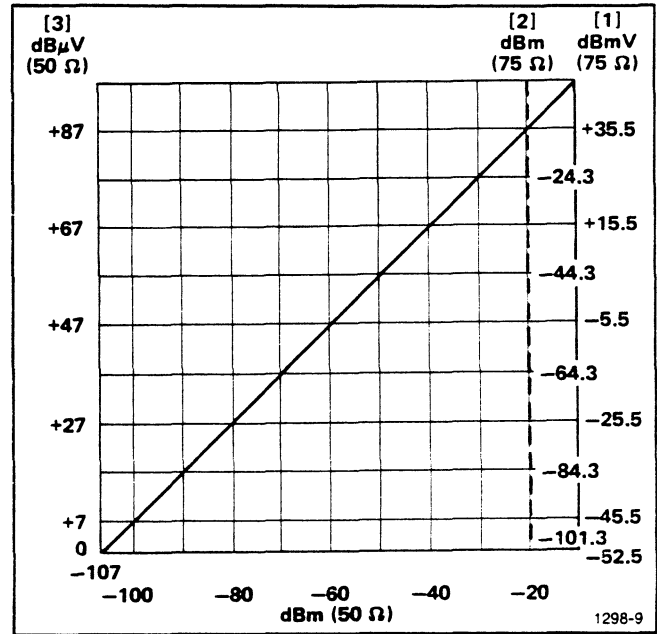

Figure 6-2. Graph illustrating the relationship between dBm, dBmV, and dBμV (matching attenuator included where necessary). When the alternate 75 Ω input is used, the reference level readout is correct for any units without additional conversions.

Amplitude Conversion — A conversion chart, as shown in Figure 6-3, can be used to convert input signal levels of voltage or power to dBm, dBV, dBmV, and dBμV.

Resolution Bandwidth, Frequency Span, and Sweep Time

Resolution is the ability of the spectrum analyzer to display discrete frequency components within a frequency span. This ability is a function of the instrument bandwidth, sweep time, frequency span, and incidental FM. Bandwidth also has an effect on the noise level. As the bandwidth decreases, the signal-to-noise ratio, or sensitivity, increases so maximum sensitivity is attained with the narrow resolution bandwidths.

As the spectrum analyzer sweep rate is increased, a critical rate is reached where both sensitivity and resolution are degraded. Therefore, sweep time for a calibrated display is dependent on the resolution bandwidth and frequency span.

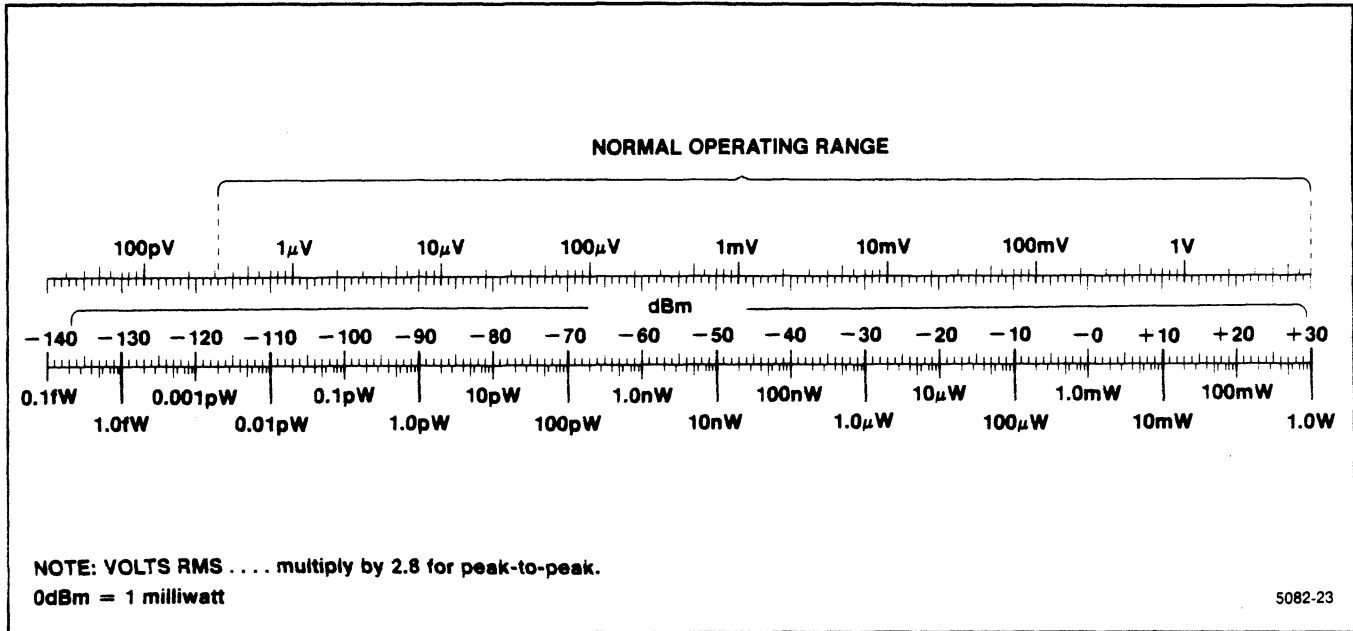

Figure 6-3. Volts-dBm-Watts conversion chart for 50 Ω impedance.

In MAX SPAN, the display represents the full frequency range. The frequency readout on the crt is indicated on the display by a frequency dot if markers are off or by the primary marker if markers are turned on. This frequency point will shift to center screen when the FREQ SPAN/DIV is reduced to some setting other than MAX. The frequency span/division setting depends on the particular measurement application. Wide spans are usually used to monitor a frequency spectrum for spurious signals, or check harmonic content. When wide spans are used for non-digital store displays, the sweep rate is usually set for minimum flicker, which requires wider resolution bandwidths to maintain a calibrated display. Narrow spans are used to analyze the characteristics about or near a particular signal, such as modulation side bands, bandwidth, or power line related distortion. Slow sweep rates are required when using narrow spans and high resolution to observe signal phenomena.

The spectrum analyzer will select the sweep rate and resolution bandwidth so the display remains calibrated for the selected frequency span/division, if TIME/DIV is in the AUTO position and AUTO RESOLN is on. AUTO RESOLN optimizes bandwidth for the selected FREQ SPAN/DIV and TIME/DIV settings unless either is outside the range of calibration. When this occurs, UNCAL lights and a > symbol prefixes the REF LEVEL readout on the crt display.

To analyze pulsed signals, a wider bandwidth than that provided by the automatic feature is usually required. Set RESOLUTION BANDWIDTH to approximately 1/10 the side lobe frequency width or the recipro-

cal of the pulse width, if known, in order to ensure adequate bandwidth. The resolution bandwidth is usually set for optimum main lobe detail after the sweep rate has been selected.

Using the HELP Feature

When there is a question about the function of any front-panel pushbutton or control, press HELP then press the pushbutton or turn the control in question. A message displayed on the crt describes the function. The functions of all of the blue-labeled and green-labeled pushbuttons can be called up without pushing the entire pushbutton-sequence each time; just push the appropriate SHIFT pushbutton, push HELP, then push all of the pushbuttons as desired. An example of this is <blue-SHIFT> HELP PLOT then REF LEVEL then READOUT and so on.

HELP will also provide explanations for the functions available from the marker menu. For detailed instructions, see Marker Menu and Assign Menu under Using the Markers Feature later in this section.

HELP is also useful in error detection (see Error Detection later in this section).

Using the Signal Identifier

The spectrum analyzer features a Signal Identify mode to help identify true signals from false signals. When in this mode, the frequency of the local oscillators

are shifted on alternate sweeps. At the same time, the sweeps are vertically displaced about two divisions. True signals shift only a small amount on alternate sweeps, while false signals or spurious responses will shift at least 1 division.

This mode can only be activated when the **FREQ SPAN/DIV** is 50 MHz or less.

The 1st LO is not phase locked when the **FREQ SPAN/DIV** is 500 kHz or more. Therefore, true or real signals can shift a slight amount between sweeps, due to limits of the oscillator setting accuracies. True signals can shift up to 2 MHz, but false signals will shift 70 MHz or more. If there is any question as to whether the signal is true or false, decrease the **FREQ SPAN/DIV** setting to 200 kHz or less so the oscillator is phase locked.

Figure 6-4 illustrates two typical examples of signal identification.

Using the Video Filters

The video filters restrict the video bandwidth so noise is reduced (see Figure 6-5). When signals are closely spaced, the filter can reduce the modulation between two signals to make it easier to analyze the display. The filters can also be used to average the envelope of pulsed RF spectra that has a relatively high pulse repetition frequency (prf); however, because the filter is basically an integrating circuit, the video filter will not be very effective when measuring low prf spectra.

The **WIDE** filter reduces the bandwidth to approximately 1/30th the selected resolution bandwidth; the **NARROW** filter to approximately 1/300th. Using the filter may require a reduction in the sweep rate to maintain a calibrated display. **UNCAL** lights if the sweep rate is not compatible with the other parameters to maintain a calibrated display. When either the **WIDE** or **NARROW** filter is selected, the filter bandwidth is displayed on the crt lower readout line.

Using Time Domain Operation

When the **FREQ SPAN/DIV** is zero, the spectrum analyzer functions as a tunable receiver to display time domain characteristics within the selected resolution bandwidth. Characteristics like modulation pattern and pulse repetition rates can now be analyzed with **TIME/DIV** selections. Resolution bandwidth is usually maximum (1 MHz) for time domain analysis of the signal.

Triggering the Display

The Triggering mode is usually **FREE RUN** for spectrum displays. However, it may be desirable or necessary to trigger the display when the event is time related to some source, or when the frequency span has been

reduced to zero for time domain analysis. In **FREE RUN**, the sweep will not synchronize with any input signal.

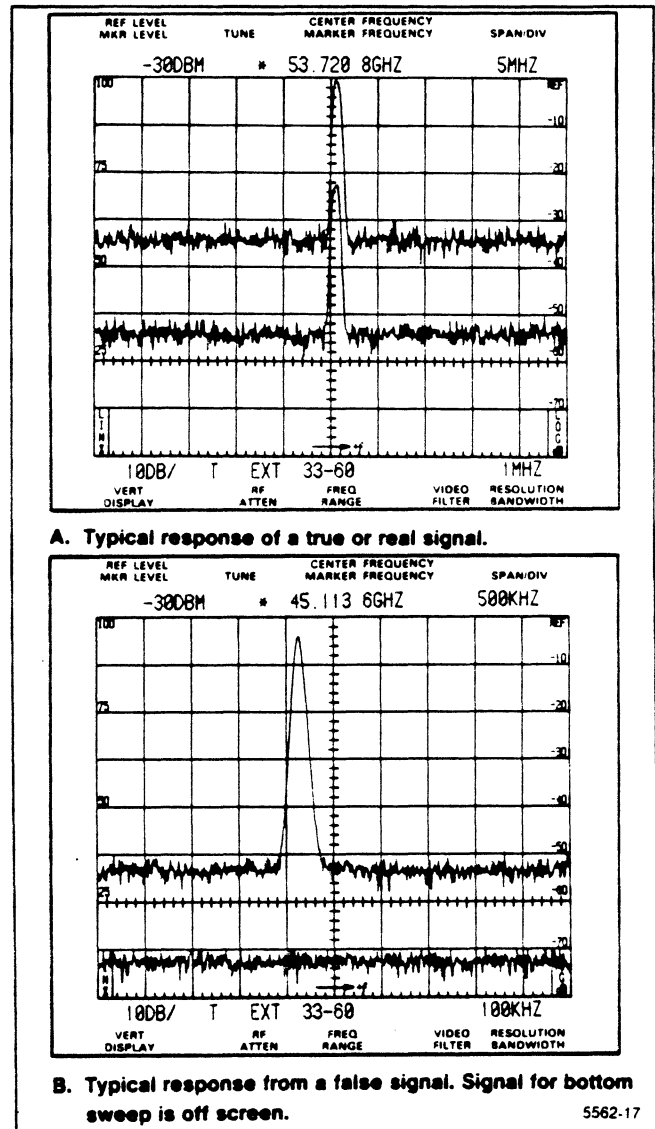

Figure 6-4. Typical example of Identifier mode displays.

In addition to **FREE RUN**, the sweep can be internally triggered (**INT**) by the video signal, at the line frequency rate of the power supply (**LINE**), or by an external signal (**EXT**) applied to the **HORIZ/TRIG EXT IN** connector on the rear panel. The required amplitude for triggering is 2.0 divisions or more for internal triggering and from 1.0 to 50 V maximum (dc + peak ac) for external triggering.

In addition to the Triggering source selections, **SINGLE SWEEP** is provided. In **SINGLE SWEEP**, the sweep will run once after the circuit has been armed and a trigger signal arrives. **READY** lights when the circuit is armed and waiting to be triggered and remains lit during sweep time. Push **SINGLE SWEEP** once to activate the Single Sweep mode and cancel the current sweep. Push

SINGLE SWEEP again to arm the trigger circuit so it is ready for a trigger signal. This mode is useful for viewing single events.

External input impedance is approximately 10 kΩ.

The beam can be manually positioned by the MANUAL SCAN control when TIME/DIV is in the MNL position (see Manual Scan of the Spectrum that follows).

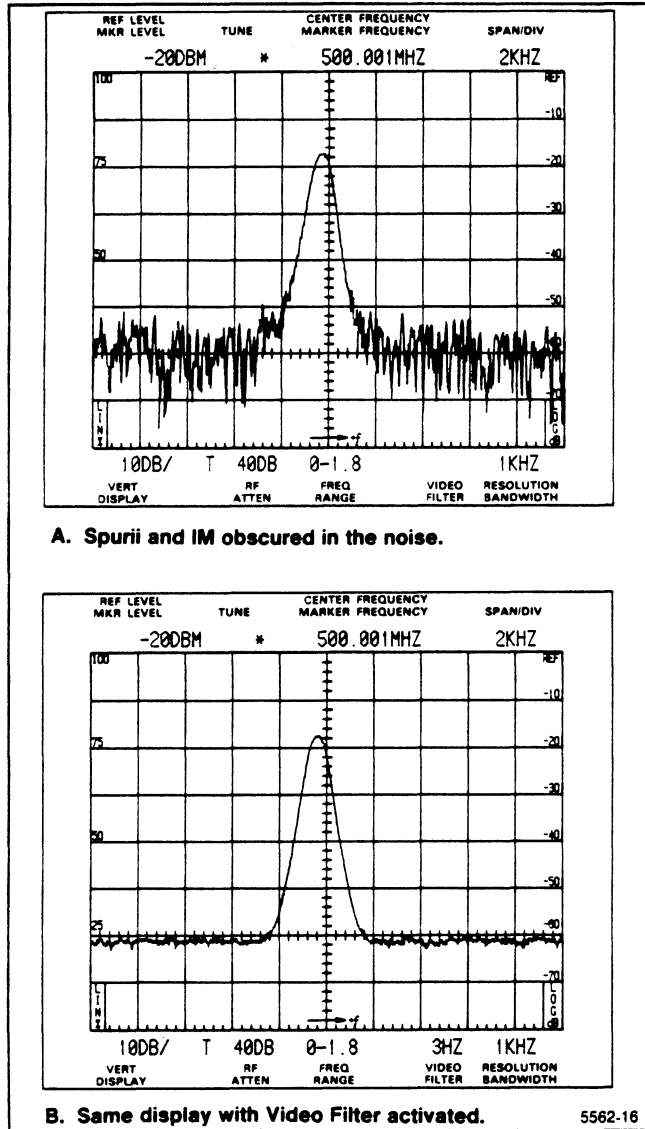

Figure 6-5. Typical display mixed with the VIDEO FILTER.

Sweeping the Display

Horizontal sweep voltage for the display can be internal or from an external source. Sweep rate and source are selected with the TIME/DIV control. When the TIME/DIV control is in the AUTO position, the sweep rate is automatically set to maintain a calibrated display.

When TIME/DIV is in the EXT position, a signal source of 0 to +10 V, applied to the HORIZTRIG EXT IN connector will sweep the crt beam across the 10 division span. The input is dc coupled and sensitivity is 1 V/div.

Manual Scan of the Spectrum

The MANUAL SCAN control is usually used to examine a particular point or sector of a display. One example is looking at one of the null points of a frequency modulation spectrum. Another example is when it takes unnecessarily long to look at a small segment of the full span because of the slow sweep rate. With a wide span/div and/or a narrow resolution bandwidth, it is very possible to manually scan too fast to achieve an accurate display. Best results are obtained without digital storage; digital storage can produce unpredictable results due to the sweep rate, and the digital storage display is only updated when scanning from left to right.

Reference Level, RF Attenuation, and Vertical Display

When a change is made to REF LEVEL, the gain distribution is automatically selected (IF gain and input RF attenuation) for the new reference level. The selection is made according to the settings of VERTICAL DISPLAY, FINE, MIN RF ATTEN dB, and MIN NOISE/MIN DISTORTION.

The amount of input RF attenuation set is based on the reference level requested and the settings of MIN RF ATTEN dB and MIN NOISE/MIN DISTORTION. The spectrum analyzer assumes the MIN RF ATTEN dB selection is the minimum attenuation required for the expected signal levels, and will not reduce RF attenuation below this value. As MIN RF ATTEN dB is increased, the lowest reference level is raised an equal amount. At 0 dB minimum attenuation, the lowest reference level is -117 dBm; at 10 dB minimum attenuation, the lowest reference level is -107 dBm, and so on. The best ratio of RF attenuation IF gain is selected according to the Minimum Noise/Minimum Distortion mode (see the description later in this section).

The REFERENCE LEVEL control steps depend on the VERTICAL DISPLAY and FINE settings. With LOG selected, the REFERENCE LEVEL control steps in 1 dB to 15 dB increments with FINE off. With FINE on, it steps in 1 dB increments for display factors of 5 dB/div or more and 0.25 dB for display factors of 4 dB/DIV or less. The 0.25 dB increments apply to the Delta A mode (see the description later in this section). With LIN selected and FINE off, the bottom of the crt graticule is zero volts, and the top of the crt graticule is eight times the vertical display factor. The display factor changes in a 1-2-5 volts/division sequence from 500 mV to 50 nV with FINE off. With FINE on, the reference level changes in 1 dB

steps and the scale factor/division is 1/8 the voltage equivalent of the REFERENCE LEVEL.

Alternate Reference Level Units Selection

It is a simple procedure to select an alternate to dBm reference level units. For example, the REF LEVEL readout is 0 dBm. Press <blue-SHIFT> REF LEVEL UNITS to get the reference level units menu. To change to dBV, select 1 from the menu, and the REF LEVEL readout changes to -13 dBV. To change to dBmV, select 2 from the menu, and the REF LEVEL readout will change to 47 dBmV. To change to dB, select 3 from the menu, and the REF LEVEL readout changes to 107 dB. To change back to dBm, select 0 from the menu, and the REF LEVEL readout changes to 0 dBm.

Using the Delta A Mode

To select the Delta A mode, push FINE while the vertical display factor is 4 dB/div or less. The REF LEVEL readout goes to 0.00 dB and the REFERENCE LEVEL control steps in 0.25 dB increments from this reference.

The Delta A mode accurately measures signal-relative amplitude difference. This is possible because the gain distribution (IF gain and RF attenuation) does not change in the Delta A mode. The REF LEVEL is changed by shifting the log amplifier offset. The total range of the Delta A mode is 58 dB. The measurement range depends on the REF LEVEL that is current at the time the Delta A mode is activated. It is typically at least 0 to 48 dB below the REF LEVEL that was current at the time the Delta A mode was activated. The overall instrument reference level range of -117 dBm to +30 dBm cannot be exceeded.

The Delta A mode is turned off when the vertical display factor is increased above 4 dB/div or FINE is turned off; by pushing the FINE pushbutton or changing the gain distribution with MIN RF ATTEN dB or MIN NOISE selections.

Signals with large amplitude differences that are within the Delta A range can be compared without the distortion usually introduced when signals are driven off-screen. Signals shifted off-screen by changes in the Delta A reference level are not overdriving the input. This is because the attenuator and IF gain do not change; so, the mixers do not see any change in signal levels even though the Delta A reference level changes.

Follow these five steps to measure the amplitude level differences of two signals.

1. Select the Delta A mode by pressing FINE. Select a vertical display of 4 dB/div or less with the dB/DIV DATA ENTRY pushbutton or push the 2 dB/DIV pushbutton.

2. Set the peak of the larger signal to a graticule line with the REFERENCE LEVEL control.

3. Press the FINE pushbutton twice to turn the Delta A mode off an on. The readout will return to 0.00 dB.

4. With the REFERENCE LEVEL control, set the peak of the lower amplitude signal to the same graticule line established in step 2.

5. The REF LEVEL readout will now indicate the amplitude difference between the two signals in dB.

NOTE

Do not confuse the Delta A mode with the delta marker mode.

Using MIN NOISE or MIN DISTORTION

One of two methods can be selected to control RF attenuator and IF gain settings. MIN NOISE minimizes noise level by decreasing input attenuation and IF gain by 10 dB. MIN DISTORTION minimizes input mixer overload by increasing input attenuation and IF gain 10 dB. MIN DISTORTION is the normal mode of operation.

CAUTION

With MIN NOISE on and MIN RF ATTEN dB set to 60 dB, the REF LEVEL can be set to +40 dBm. Do not increase input signal level to full screen with a REF LEVEL of +40 dBm because this will exceed the attenuator rating.

Using Digital Storage

Digital storage provides a smooth, flicker-free display. Two complete displays can be digitized and stored. In addition, the instrument Store Display and Recall functions will store up to nine displays in memory (see Using the Store and Recall Features later in this section). One of the two digitized waveforms can be saved and then compared to later waveforms. The Max Hold feature updates digital storage data only when the input signal amplitude is greater than previous data. This allows monitoring and graphic plotting of display changes (amplitude and frequency) with time.

The display is divided by a horizontal line that is positioned with the PEAK/AVERAGE control. Above the line, video information is peak detected; below the line, signal averaging occurs. This feature subdues noise in the por-

tion below the line and allows full peak detection above the line. An intensified spot on the line indicates the horizontal position where memory is being updated. The average (number of samples) is a function of the sweep rate; the slower the rate the more samples.

The digital storage display is divided into an A and B section. Data can be stored in either A or B or in both. There are 500 horizontal locations in A and 500 horizontal locations in B. When both are displayed, the origin of the B waveform is shifted so the A and B coordinates are interlaced to provide 1000 display increments. Data in memory is continually updated with each sweep so the display is always current.

When SAVE A is turned on, data in the A section is saved and only the B section of storage is updated. This takes place whether the A waveform is displayed or not. This mode captures an event or waveform, with its readout, for comparison with a subsequent event displayed by the B display. If VIEW B is on, the readout applies to the current B waveform. If SAVE A and VIEW A are on and VIEW B and B-SAVE A are off, the readout applies to the saved A waveform.

When B-SAVE A is turned on, the arithmetic difference between the B waveform and the saved A waveform is displayed (see Figure 6-6). This convenient mode can be used to align filters or other devices. The reference waveform is stored in A and the unknown is displayed by B. The reference level is usually set mid-screen so positive and negative quantities can be observed. The position of the zero reference can be changed by an internal switch. Contact qualified service personnel to have the reference level repositioned.

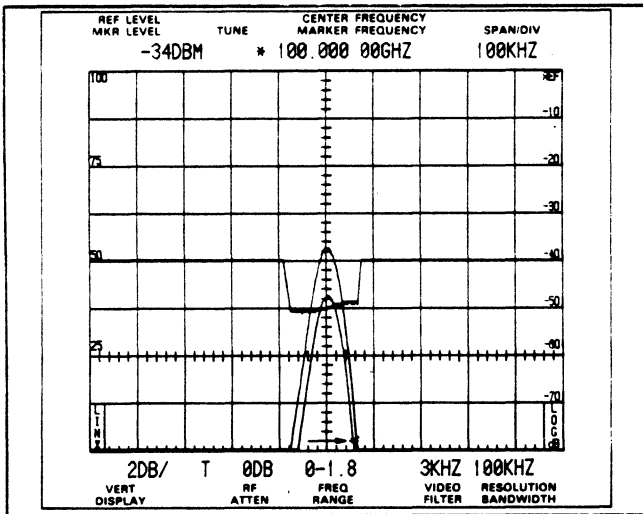

Figure 6-6. Typical display using B-SAVE A to observe the difference between SAVE A and B displays.

MAX HOLD causes the memory to be updated only if the new input is of higher magnitude than the former (B memory only if SAVE A is active). This allows monitoring of signals that may change with time and provides a

graphic record of amplitude/frequency excursions.

Signal averaging is useful for suppressing noise. The number of samples averaged per horizontal digitized slot is a function of the spectrum analyzer sweep rate. The slower the sweep speed, the more samples averaged per horizontal slot. Resolution bandwidth affects the amplitude difference between peak detected and average levels of cw signals. When the resolution bandwidth is less than 1/30th the span/division (e.g., 100 kHz or less with 5 MHz span/div) there will be significant error in the average amplitude levels of cw signals, especially if only A or B is displayed. The peak value will be the true value. When using narrow resolution bandwidth with wide frequency spans, it is best to run digital storage with both the A and B waveforms interlaced and the cursor (horizontal line) at the bottom of the display.

To measure signal amplitude level, set the cursor to the bottom of the screen. To average noise, set the horizontal line at least one division above the noise level.

Using the Store and Recall Features

The spectrum analyzer features two functions to store up to nine waveforms, with marker(s) and readout, in memory to be recalled later for review or analyses. To save the display currently on the screen, press <blue-SHIFT> STORE DISPLAY, the register number (0-8) where you want to store the display, and if SAVE A is on the identity of the display you want stored (A or B). To later recall this same display, press <blue-SHIFT> RECALL, and the register menu showing the center frequency of each stored display will appear on the crt. Select the correct register number with a DATA ENTRY pushbutton, and then select the part of the digital storage (A or B) where you want to place the recalled display.

SAVE A is automatically activated to prevent an overwrite. If location A is selected, VIEW A must be on to see the recalled display and VIEW B must be off to see the readout that applies to the recalled display. If VIEW B and VIEW A are on, both the display recalled in A and the current display in B will be visible on the screen. The readout shown applies to the current B display. Turn VIEW B off to see the readout that applies to the recalled A display.

If location B is selected, the next sweep will overwrite the display unless SINGLE SWEEP was activated before selecting B; a message will appear on the screen as a reminder of this. VIEW B must be on to observe the recalled display. Remember to deactivate SINGLE SWEEP when leaving this recalled mode.

Plotting the Display

Press PLOT (495) or <blue-SHIFT> PLOT (495P) to drive many external plotters such as the Tektronix 4662 Option 01, 4662 Option 31, or 4663 (emulating the 4662); the Hewlett-Packard HP7470A or HP7475A, HP7580B, HP7585B, or HP7486B; or the Gould 6310 or 6320.

To use the plot feature, connect the plotter to the spectrum analyzer with a IEEE STD 488 (GPIB) cable, and complete the following steps.

1. Set the corners of the plot for a 3:2 aspect ratio for the Tektronix plotters, or 6:5 for the Hewlett Packard and Gould plotters. The plotter must be in the Listen Only mode and the spectrum analyzer must be in either the TALK ONLY or TALK/LISTEN ONLY mode. The 495 is internally-strapped for the correct mode. On the 495P, the appropriate switches on the rear-panel GPIB ADDRESS switch must be closed or in the 1 position.

2. Set the plotter interface switches as follows:

Tektronix 4662 Option 01 or 4662 Option 31 (rear panel)

A = 0, 1, 8, or 9
B = C or D
C = X (don't care)
D = X (don't care)

Tektronix 4663

Interface Select = 1 if Option 04 or 2 if Option 01
Initial Command/Response Format = 5
Interface Mode = Listen Only

Hewlett-Packard or Gould Plotters

Address = 31

3. Press <blue-SHIFT> SAVE A on the spectrum analyzer, and select the desired plotter type from the menu on the crt. The selection is stored in memory and does not need to be selected again unless the plotter type is changed.

4. Select the display and the information that you wish to plot. The Plot feature is similar to using a camera, in that a plot is made of everything that is turned on for the crt display. The information plotted depends on the setting of several front-panel pushbuttons and controls. If READOUT is on, the crt readout will be plotted with the display. If GRAT ILLUM is on, the bezel and graticule information will be included with the plot. If VIEW A, VIEW B, or B-SAVE A are on, these waveforms will be part of the plot. By the same token, if any of these functions are off, they will not be plotted.

The zero level for a B-SAVE A waveform is usually the graticule center line. (Switches within the instrument can set the level. Contact your service personnel for this change.) If you desire to shift the zero level for the plotting function only, press <blue-SHIFT> B-SAVE A, and enter the desired level in display units (25 is the bottom

graticule line, 25 units/div). This zero level is retained in memory. It is not related to the display zero level, since the processor has no way of determining the internally-set zero level for the crt display or no way of changing it.

Using the Markers Feature

The marker modes provide direct readout of frequency and amplitude information of any point along any displayed trace. Relative (delta) frequency and amplitude information between any two points along any displayed trace or between traces is also available. Two independent marker frequencies and amplitudes cannot be displayed at the same time.

Marker Terms — The following definitions of marker terms are used throughout this section.

- Live Trace — Any combination of the A trace when SAVE A is off and/or the B trace. A trace recalled into B is not an active trace.
- Active Trace — A Live Trace or the B-SAVE A trace (a trace recalled into B is not an active trace).
- Inactive Trace — A SAVE A trace or a trace recalled into the B display before the sweep is started.
- Primary Marker — The marker displayed in the Single Marker mode whose frequency and/or position is changed when tuning with the CENTER/MARKER FREQUENCY control. When two markers are displayed, the brightest marker is the Primary marker.
- Secondary Marker — The "second" marker; displayed only in the Delta Marker mode.

Marker Turn On — The Single Marker mode places one marker (Primary marker) on the spectrum to display marker frequency and amplitude. The Delta Marker mode places two markers (Primary marker and Secondary marker) that display the difference in frequency and amplitude between the two markers. When two markers are displayed, the Primary marker is brighter. The Primary marker position and frequency can be changed with the CENTER/MARKER FREQUENCY control or from the GPIB.

The marker(s) can be turned on by pushing many of the pushbuttons related to marker action.

- TUNE CF/MKR (pushbutton lit) turns on the Primary marker
- <Blue-SHIFT> MKR → CENTER turns on the Primary marker
- <Green-SHIFT> PEAK FIND turns on the Primary marker

- <Green-SHIFT> SIGNAL TRACK turns on the Primary marker
- <Green-SHIFT> MKR → REF LVL turns on the Primary marker
- <Green-SHIFT> 1—MKR→2 turns on both the Primary and Secondary markers
- <Green-SHIFT> Δ MKR turns on both the Primary and Secondary markers

There are three pushbutton sequences that turn the marker(s) off.

- <Blue-SHIFT> MKR OFF turns off all marker functions
- <Blue-SHIFT> INIT turns off all marker functions (the instrument is returned to the initial turn-on condition)
- <Green-SHIFT> Δ MKR (when both markers are on) turns off the Secondary marker and returns the instrument to the Single Marker mode

The markers are visible only when DIGITAL STORAGE functions are on; there can be no markers on a real-time trace. Any marker(s) on a trace will be stored and recalled with the trace visible on recall only if the markers are on. In either the Single or Delta marker mode, a second line of readout appears at the top of the crt. In the Single Marker mode, the marker frequency readout is displayed directly below the center frequency readout, and the marker amplitude is displayed directly below the reference level readout. In the Delta Marker mode, the frequency of the Primary marker with respect to that of the Secondary marker is displayed directly below the frequency readout, and the amplitude of the Primary marker with respect to that of the Secondary marker is displayed directly below the reference level readout. When in the Delta Marker mode, the relative amplitude and frequency readouts are enclosed on the screen in parentheses. If the marker amplitude is outside the digital storage range, OVER or UNDER is displayed in the amplitude readout field.

Marker Menu and Assign Menu — Most of the marker functions are available directly from front-panel pushbutton sequences. There are additional marker functions that are available either by direct selection from the Marker Menu, or after they have been assigned from the Assign Menu to either the ASSIGN 1 or ASSIGN 2 pushbutton. Press MARKER MENU to show a list of additional marker functions. These functions are all available simply by selecting them with the correct DATA ENTRY number pushbutton (see MARKER MENU under MARKER FUNCTIONS in Section 4 of this manual for the description of these functions).

Follow these steps to assign a function to the ASSIGN 1 or ASSIGN 2 pushbutton. (Once a function has been assigned, it will remain until the pushbutton is assigned a different function.)

1. Select 6—ASSIGN FUNCTION TO KEY. This will bring up the Assign Menu that contains the functions that can be assigned.
2. Push the correct DATA ENTRY number pushbutton.
3. For functions 0 through 3 or 6
 - a. The two ASSIGN pushbuttons will light.
 - b. A message will appear that asks you which pushbutton you want to use for that function.
 - c. Push the desired pushbutton.
 - d. The assignment has been made.
4. For functions 4 or 5
 - a. A message prompts you to enter the amount you want the marker to move.
 - b. Enter the amount and units selection.
 - c. The two ASSIGN pushbuttons will light.
 - d. A message will appear that asks you which pushbutton you want to use for that function.
 - e. Push the desired pushbutton.
 - f. The assignment has been made.

Once a function has been assigned, you can get a description of the function by pressing <green-SHIFT> HELP and the correct ASSIGN pushbutton.

Assigning Markers — When the marker mode is first turned on from the front panel, the trace(s) on which the marker(s) appears is determined by the traces that are currently displayed, as indicated in Table 6-2. When a trace is turned off, any marker(s) on it are re-located according to Table 6-2. When a trace is turned on, the previous marker locations do not change; except, the marker always jumps to the active trace in maximum span or when in the Signal Track mode.

Tuning Markers — Move the Primary marker with the front-panel CENTER/MARKER FREQUENCY control (when the TUNE CF/MKR pushbutton is lit). To make it possible to change the position of the Secondary marker, you must make the Secondary marker be the Primary marker. Push <green-SHIFT> 1—MKR→2 to swap the Primary and Secondary marker positions. Move the Primary marker (which used to be the Secondary marker), and then push <green-SHIFT> 1—MKR→2 again to swap the Primary marker back to its previous location.

The marker normally moves over the fixed display. Marker tuning (both frequency and position) stops when the screen edge is reached while using the CENTER/MARKER FREQUENCY control. If the marker is on a trace containing a band edge, the marker may be tuned over the in-band portion only. This is true for both active and inactive traces. However, if the marker is on the B—SAVE A trace and the A trace contains a band edge but the B trace does not, the tuning is not limited.

Table 6-2
MARKER TRACE ORGANIZATION

LIVE TRACE	VIEW A AND SAVE A	B-SAVE A	PRIMARY MARKER ON	SECONDARY ^a MARKER ON
Off	Off	Off	Off	N/A
On	Off	Off	Live	Live
On	On	Off	Live	SAVE A
On	Off	On	Live	Live
On	On	On	Live	SAVE A
Off	On	Off	SAVE A	SAVE A
Off	On	On	B-SAVE A	B-SAVE A
Off	Off	On	B-SAVE A	B-SAVE A

^aThe secondary marker appears only when delta markers are on. The primary and secondary markers may be toggled with the front-panel 1-MKR-2 pushbutton.

The marker tuning rate depends on the speed with which the TUNE CF/MKR control is turned. If the control is turned rapidly, the marker moves 1/10 of a division per increment. If the knob is turned quite slowly, the marker moves 1/100 of a division per increment. At intermediate turning speeds, the marker moves approximately 1/30 of a division per increment.

When two markers are displayed (delta-marker mode) and the marker frequency, center frequency, and span are changed, the Secondary marker remains fixed at its original frequency and is allowed to move off the screen. If the Primary and Secondary markers are swapped (with the <green-SHIFT> 1-MKR-2 pushbutton) while the Secondary marker is off the screen, the display is centered on the frequency of the old Secondary marker (now the new Primary marker). The old Primary marker (now the new Secondary marker) is placed off the screen.

Error Detection

When an internal error is found in the spectrum analyzer, the words ERROR USE HELP will flash one after the other at the right end of the marker readout line (or just a steady ERROR will appear when under remote control). This message appears when the markers are on or the instrument is in MAX. Press HELP to read the definition of the problem and the probable effects of the problem. If the markers are off and the measurement is not in MAX, the error message will be steady and will specify the problem area. Additional information and servicing instructions are in the diagnostics information in the Maintenance section of the Service Manual, Volume 1. If you cannot solve the problem with the HELP information, report all problems or error information to qualified service personnel.

Using the Automatic Performance Testing Feature

<Blue-SHIFT> CAL activates a routine that tests frequency and relative amplitude of the IF filters. This routine should be done any time the temperature changes. Settings are held in memory after the test routine has run. Refer to Display Parameter Controls in Section 4 for further information.

Using the Tracking Generator Mode

In order to obtain higher frequency accuracy when using the tracking generator, the Tracking Generator mode disables use of the frequency correction factors for all resolution bandwidth filters wider than 10 kHz. These wide filters may be centered too far from 10 MHz for the difference to be corrected with the Tracking Adjust control on the tracking generator.

All amplitude correction factors are always used.

For maximum frequency and amplitude accuracy, always adjust the Tracking Adjust control to peak the response in the resolution bandwidth filter you are using. Remaining amplitude errors can be corrected by using the B-SAVE A mode of digital storage.

When the Tracking Generator mode is enabled, a T appears on the right side of the second top readout line, except when an error message is being displayed.

Using the Sideband Analyzer Mode

Since the 1405 sideband analyzer only uses the first local oscillator of the spectrum analyzer, it is only useful when the first local oscillator is sweeping (not phase locked). The Sideband Analyzer Mode extends the usefulness of the 1405 by causing the spectrum analyzer to phase lock in 50 kHz/div instead of the normal 200 kHz/div.

When the Sideband Analyzer mode is enabled, an S appears on the right side of the second top readout line, except when an error message is being displayed.

PROGRAMMING FEATURES (495P GPIB OPERATION)

Setting GPIB Address Switches

The general purpose interface bus (GPIB) ADDRESS switches on the rear panel set the value of the instrument's GPIB addresses. The Programmers manual contains details of how the switches are used in remote control operations.

The switches can be set as desired, except when using Tektronix 4050-Series controllers. They reserve address 0 for their own use. Selecting a primary address of 31 logically removes the instrument from the bus; it does not respond to any GPIB address, but remains both unlistened and untalked. If the switches are changed after power-up, the RESET TO LOCAL or <blue-SHIFT> PLOT pushbutton must be activated so the spectrum analyzer will update the primary address.

TALK ONLY, LISTEN ONLY Switches

The spectrum analyzer switches for talk-only and listen-only operation are part of the GPIB ADDRESS switch bank. Set either or both switches (you can have talk only, listen only, or both talk only and listen only features). If the spectrum analyzer power is on, press RESET TO LOCAL or <blue-SHIFT> PLOT for a change in these switches to take effect. Both the TALK ONLY and LISTEN ONLY switches must be off (down) when the spectrum analyzer is used with any controller.

Set the LF OR EOI switch to EOI (down) for use with Tektronix equipment. The switches marked 1, 2, 4, 8, and 16 may be set to any combination except all ones (decimal 31), which logically disconnects the spectrum analyzer from the bus or all zeroes when using the instrument with a 4050-Series controller.

Connecting to a System

Connect the programmable spectrum analyzer to a GPIB system through the GPIB cable supplied with the instrument. Connect the cable after the power to the spectrum analyzer has been turned on or the controller is turned off to avoid generating interference on the bus.

OPERATIONAL CONSIDERATIONS AND PRECAUTIONS

Following are some operational precautions to observe and traps that can occur when analyzing displays.

1. ⚠ RF INPUT Power Limit

CAUTION — DO NOT EXCEED THE RF INPUT POWER LIMIT OF +30 DBM. DO NOT APPLY DC VOLTAGE TO THE RF INPUT.

2. Instrument Warm-up After Storage

After storage below -15°C , allow 15 minutes instrument warm-up time, then turn the power off and back on.

3. Auto Resolution

Use AUTO RESOLN with care when measuring absolute amplitude level. Always use a bandwidth wider than the incidental FM of the signal source.

4. Level of Pulsed Signals

The spectrum for a pulsed signal is spread out. Consequently, the height of the crt response is less for a pulsed signal than for a cw signal of the same peak amplitude. This loss in display height means, in effect, a loss in sensitivity. The amount of loss can be computed from the following formula.

$$\text{Voltage loss} = (t_o B)(1.5)$$

where t_o = pulse duty cycle
B = resolution bandwidth

The power of the self-generated noise increase is proportional to bandwidth. Pulsed RF voltage level is also proportional. Since power is proportional to voltage squared, a wider bandwidth gives better sensitivity and greater dynamic range for pulsed RF inputs.

When in doubt about signal level overdrive problems, reduce the signal level by inserting RF attenuation; then, repeat the measurement. If the two agree, the measurement is correct; if not, the input mixer stage is probably overdriven.

An important consideration for pulsed RF measurements is the peak signal level at the mixer. The signal level is greater by $(t_o B)(1.5)$ than the peak level displayed on the crt. Taking the sensitivity loss into account is the only way of being sure that the mixer peak power input for linear operation is not exceeded.

5. Level of Continuous Wave Signals

Problems similar to those described in 6 can occur when analyzing cw signals at relatively narrow span widths. The large cw signal may not appear on screen because its frequency is outside the set span width. The mixer, nevertheless, is saturated and will compress signals.

6. Excessive Input Signal Level

Too much input power will destroy the front-end mixer or attenuator. Replacement mixers and attenuators are costly. When working with high power signals, use couplers or other devices to reduce the signal down to acceptable levels. Once the signal is down below the rating of the RF attenuator, prevent possible mixer damage by starting with MIN RF ATTEN dB fully clockwise, then reduce attenuation if needed.

7. No Crt Trace

<Blue-SHIFT> BASELINE CLIP is used to reduce the brightness of the baseline on the crt for easier viewing of the readout. If TRIGGERING, INTENSITY, and vertical POSITION all seem to be in order and there is no crt trace, check the status of <blue-SHIFT> BASELINE CLIP; the trace may be turned off.

8. PEAK/AVERAGE

PEAK/AVERAGE should normally be fully counterclockwise so narrow signals in wide spans are not reduced in amplitude.

9. Digital Storage Effects on Signal Analyses

When using digital storage, the frequency base is divided into storage slots. For peak displays, above the cursor (horizontal line) the display point in each slot corresponds to the maximum sampled value of the signal. Samples are taken at about 9 μ s intervals. When sweeping at one second per division, this is about 1000 samples per slot. For average displays, below the cursor) the values of all samples per slot are added and divided by the number of samples to compute the display point for each slot. Each display point is connected to create a smooth display. When A or B memory are displayed independently, only half of the slots are connected. The following are a few pitfalls that can occur.

If the cursor set by PEAK/AVERAGE is above the signal level, the average value for each digital slot will be displayed. With narrow resolution bandwidths compared to the slot width, the average value of the resolution

response shape will be displayed, which has nothing to do with signal amplitude.

To avoid the above pitfalls, run digital storage with A and B interlaced. Do not set the PEAK/AVERAGE cursor to average a cw signal. It is best if the cursor is about 1/4 division above the signal to be averaged and about 1/2 division below the signal to be analyzed.

None of these restrictions apply when the resolution bandwidth is wide compared to a digital storage slot (e.g., 5 MHz/div with 1 MHz resolution).

10. Stored Display Averaged in Wide Spans

When operating in wide spans with digital storage, low level signals will be averaged with the noise and lost if the PEAK/AVERAGE cursor is above the display. Turn the control fully counterclockwise for peak detection when operating with wide spans.

11. Automatic Calibration of Relative Amplitudes of Resolution Bandwidth Filters

If a calibration failed message appears when the automatic calibration completes, refer to the correction factors for an explanation. Press <blue-SHIFT> LIN to display the correction factors held in memory. Refer to Calibrate Center Frequency, Reference Level, and Dynamic Range in Section 5 for further information.

12. TRIGGERING

TRIGGERING is set to FREE RUN for most applications. In pulsed RF applications, a triggered display is required to measure between pulse repetition lines to determine the pulse repetition rate.

Internal triggering requires one or more divisions of signal amplitude. Tune the center frequency so a reasonably-sized signal is located at the sweep start before changing the trigger source from FREE RUN to INT.

SERVICE INFORMATION

Service Manual

The spectrum analyzer Service Manuals are separate publications. The Service Manual, Volume 1, includes circuit descriptions, troubleshooting information, calibration procedures, and maintenance procedures. The Service Manual, Volume 2, includes the electrical and mechanical parts lists, standard and optional accessories, and

schematic diagrams. Service Manuals are intended for use by **QUALIFIED SERVICE PERSONNEL ONLY**. To avoid electrical shock, **DO NOT** perform any servicing unless qualified to do so. Service personnel should read the Safety information at the beginning of the Service Manuals before performing any servicing.

Product Service

To assure adequate product service and maintenance for our instruments, Tektronix, Inc. has established Field Offices and Service Centers at strategic points throughout the United States and in all other countries where our products are sold. Contact your local Service Center, representative, or sales engineer for details regarding Warranty, Calibration, Emergency Repair, Repair Parts, Scheduled Maintenance, Maintenance Agreements, Pickup and Delivery, On-Site Service for fixed installations, and other services available through these centers.

Emergency Repair

This service provides immediate attention to instrument malfunction if you are in an emergency situation. Contact any Tektronix Service center for assistance to get you on your way within a minimum of time.

Maintenance Agreements

Several types of maintenance or repair agreements are available. For example; for a fixed fee, a maintenance agreement program provides maintenance and recalibration on a regular basis. Tektronix, Inc. will remind you when a product is due for recalibration and perform the service within a specified time-frame. Refer to Options M1 through M3 in Section 7 for extended service and warranty options available. Any Service Center can furnish complete information on costs and types of maintenance programs.

*This Document is a complete Scan from the original
Tektronix manual
For enquiries about our complete
High quality line of technical Manuals in PDF
mailto : Qservice@otenet.gr*

**SEE
OTHER
SIDE**

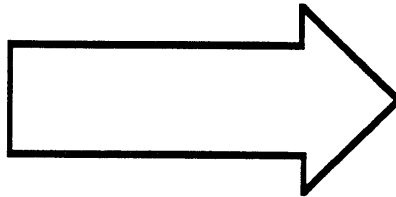

OPTIONS

This section describes the options available at this time for the spectrum analyzer. Changes in specifications, if any, are described in this section. Contact your local Tektronix Field Office or representative for additional information and ordering instructions (unless otherwise indicated).

Options are usually factory installed; however, field kits are available for some options. Contact your local Tektronix Field Office or representative for information on field kits and their installation.

Options A1, A2, A3, A4, and A5 (Power Cord Options)

There are five international power cord options offered for the spectrum analyzer (see Table 7-1). The physical descriptions of the cord plugs are illustrated in Figure 7-1. For ordering purposes, refer to the Replaceable Mechanical Parts list in the Service Manual, Volume 2, for the Tektronix Part Number.

Table 7-1
POWER CORD OPTIONS

Option	Description
A1	European, 220 V/50 Hz @ 16A
A2	United Kingdom, 240 V/50 Hz @ 13A
A3	Australian, 240 V/50 Hz, @ 10A
A4	North American, 240 V/60 Hz, @ 15A
A5	Swiss, 220 V/50 Hz, @ 10A

Options M1, M2, and M3 (Extended Service and Warranty Options)

There are three extended service and warranty options offered for the spectrum analyzer (see Table 7-2) that go beyond the basic one-year coverage. Contact our local Tektronix Field Office or representative for additional information to satisfy your specific requirements.

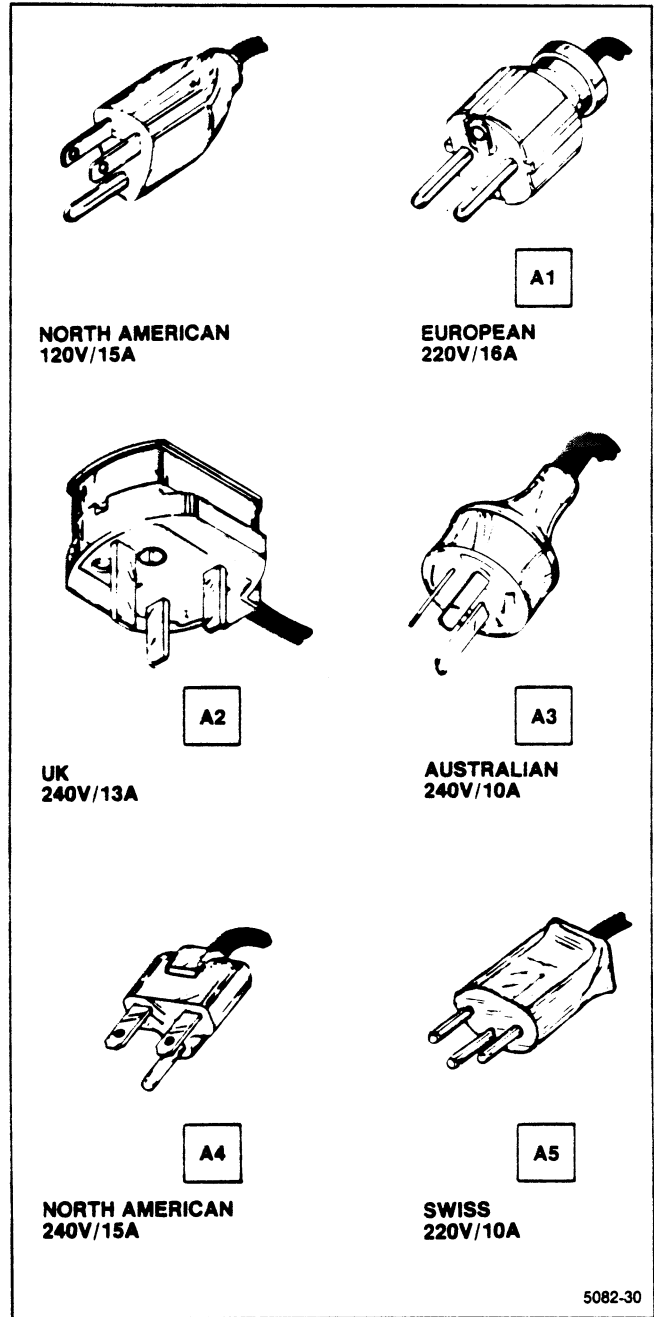

Figure 7-1. International power cord options for the spectrum analyzer.

5082-30

Option 05

Option 05 adds a frequency counter with an accurate internal reference and an external reference input. Also, there is the capability to have eight user-designed programs stored in memory. A separate Operators Manual is available for the 495/495P Option 05. Contact your local Tektronix Field Office or representative for ordering information.

Option 07 I

Option 07 provides an optional 75 Ω input, replacing the external mixer capability. Table 7-3 lists the changes and additions to the standard instrument electrical characteristics. These characteristics apply to the 75 Ω input.

Table 7-2
EXTENDED SERVICE
AND WARRANTY OPTIONS

Option	Description
M1	Two routine calibrations to published specifications; one each in years two and three of warranty coverage, plus two years remedial service
M2	Four years remedial service
M3	Four routine calibrations to published specifications; one each in years two, three, four, and five of product ownership, plus four years of remedial service

Table 7-3
OPTION 07 ALTERNATE SPECIFICATIONS

Characteristic	Performance Requirement	Supplemental Information
INPUT		
Input Impedance		75 Ω
Return Loss		17 dB (1.35:1 VSWR)
5 MHz–800 MHz		13 dB (1.6:1 VSWR) with ≥ 10 dB attenuation
800 MHz–1000 MHz		
Maximum Input Level		+75 dBmV
With 0 dB Attenuation		
With 20 dB or More Attenuation		+78 dBmV, 100 V _{dc} maximum (dc + peak)
FREQUENCY		
Center Frequency Operating Range		0–1000 MHz
Static Resolution Bandwidth	Within 20% of 300 kHz bandwidth (6 dB down)	300 kHz resolution filter replaces the standard instrument 100 kHz filter.
Frequency Response	± 2.0 dB about the midpoint between two extremes	Frequency response is measured with ≥ 10 dB RF attenuation. The response figure includes the effects of: <ul style="list-style-type: none"> • input vswr • mixer • gain variations Variations in display flatness contribute about 1 dB to the response figure.
5 MHz–1000 MHz		
Coaxial Input		
1 MHz–5 MHz		Typically <3 dB down from the 5 MHz response
AMPLITUDE		
Reference Level Range		+78 dBmV to –75 dBmV
(Full Screen, Top of Graticule)		+88 dBmV is achievable in minimum noise mode

Table 7-3 (Continued)
OPTION 07 ALTERNATE SPECIFICATIONS

Characteristic	Performance Requirement	Supplemental Information
SENSITIVITY Equivalent Input Noise Sensitivity 5 MHz to 1000 MHz 75 Ω INPUT		Measured with: <ul style="list-style-type: none"> ● 0 dB attenuation (Min Atten 0 dB) ● Narrow Video Filter ● 2 dB/Div Log mode ● Digital Storage on ● Max Hold off ● Peak/Average in Average ● 1 sec Time/Div ● Zero Span ● Input terminated in 75 Ω (terminated in 50 Ω for 50 Ω Input)
30 Hz	-81 dBmV	
100 Hz	-76 dBmV	
1 kHz	-66 dBmV	
10 kHz	-56 dBmV	
300 kHz	-41 dBmV	
1 MHz	-36 dBmV	
50 Ω RF INPUT 300 kHz	-90 dBm	
OUTPUT Calibrator Output (CAL OUT) Level	+20 dBmV \pm 0.5 dB	100 MHz comb of markers provide amplitude calibration at 100 MHz.
Impedance		
PHYSICAL Weight	Option 07 adds 7 ounces (0.2 kg) to the standard instrument. Weight with only Option 07 added is 42 lbs. 6 oz. (19.22 kg) (including cover and standard accessories, except manuals).	

Options 30 and 31

Option 30 provides the spectrum analyzer installed in a rackmount cabinet. Necessary extra cooling is provided by the addition of a larger fan. A front-panel drawer provides storage for most accessories used with the spectrum analyzer. External vibrations, from rack cooling fans or surrounding equipment, may degrade the Residual FM characteristic. Because of different rack frame types, this degradation cannot be specified. In a typical fan-cooled rack, degradation increases by a factor of two.

Option 31 provides the cabling necessary to access all the front-panel connectors at the cabinet rear panel. Because of the extra cabling, frequency response flatness may degrade at the high end of the frequency range.

Option 30 with Option 31 meets MIL-T-28800C, type III, class 5, style F specification. During verification tests, Option 30 alone and Option 30 with Option 31 are secured to the rack at the front and back (the semi-rigid cables between the front-panel connectors and the cabinet grill connectors (Option 31) are removed). Table 7-4 lists the similarities to and the changes from the standard instrument.

Table 7-4
OPTIONS 30 AND 31 (RACKMOUNT) CHARACTERISTICS
AND ALTERNATE SPECIFICATIONS

Characteristic	Description
FREQUENCY Residual FM (Option 31 only)	Degrades according to rack frame, typically by a factor of two.
AMPLITUDE Frequency Response (Option 31 only)	±1.5 dB
Residual Spurious Responses (Option 31 only)	-95 dBm or less
ENVIRONMENTAL Temperature	Meets MIL T-28800C, type III, class 5, style F specifications as follows
Operating	0°C to 50°C
Non-operating	-55°C to +75°C
Humidity	
Operating Temperature Range 0°C to +25°C	95% +5%, -0%
+25°C to +40°C	75% ±5%
+40°C to +50°C	45% ±5%
Non-operating	95% +5%, -0% (Same as standard instrument)
Altitude	
Operating	10,000 feet
Non-operating	40,000 feet
Vibration Operating	Method 514 Procedure I (modified)/MIL-STD-810D. Vibration limit is 1g. Resonance searches along all three axes at 0.0065 inch displacement, frequency varied from 5 Hz to 55 Hz for 15 minutes per axis. Dwell for an additional 10 minutes per axis at the major resonant frequency or 33 Hz, if no resonance is found. Resonance is defined as twice the input displacement. Total vibration time of 75 minutes. Instrument secured to vibration platform during test.
Transportation	
Package Vibration	Meets National Safe Transit Association's pre-shipment test (project 1A-B-1) when correctly packaged. One hour vibration of 1g.
Package Drop	Operable after a 24-inch drop on any corner or flat surface.
Electromagnetic Interference (EMI)	Within limits described in MIL-STD-461B Part 4 (same as standard instrument).
PHYSICAL	
Weight, with standard accessories, except manuals	Adds 20 lbs. (9.1 kg) to the standard instrument for a total weight of 62 pounds (28.1 kg), maximum.
Dimensions, without side rails	8.75 × 16.89 × 25.00 inches (222 × 429 × 635 mm)
SAFETY	Same as the standard instrument.
ACCESSORIES	
Standard	Same as the standard instrument, with the addition of rack slides.
Optional	Same as the standard instrument, except the hard transit case is not available.

Option 39

Option 39 provides silver batteries for the instrument's battery-powered memory. The battery life at +55°C is 1–2 years and 2–5 years at +25°C. We recommend removing the silver batteries during long-term storage.

Option 42

This option provides a 110 MHz IF output with bandwidth greater than 5 MHz for broadband, swept receiver applications. Table 7-5 lists the changes from the standard instrument.

Table 7-5
OPTION 42 ALTERNATE SPECIFICATIONS

Characteristic	Performance Requirement	Supplemental Information
FREQUENCY		
Center Frequency	108.5 MHz to 111.5 MHz	
3 dB Bandwidth	> 5 MHz	
Bandpass Ripple	≤ 0.5 dB	
Symmetry about 110 MHz	± 1.0 MHz	
POWER		
Power Out With –30 dB Input and Signal at Full Screen		Nominal output impedance is 50 Ω 1 dB compression of output ≥ 0 dBm, in Minimum Distortion Mode only.

Option 45 (495P Instruments Only)

This option provides the spectrum analyzer with the software/firmware necessary to meet Modular Automated Test Equipment Compatibility Options (MATECO). A MATECO Programmers Manual is included as an accessory with this option.

Option 52

Option 52 provides a North American 220 V configuration with the standard power cord. The fuses are replaced with 2A slow blow.

*This Document is a complete Scan from the original
Tektronix manual
For enquiries about our complete
High quality line of technical Manuals in PDF
mailto : Qservice@otenet.gr*

**SEE
OTHER
SIDE**

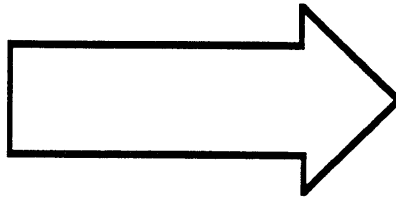

GLOSSARY

The following glossary will help you better understand terms as they are used in this document and with reference to spectrum analyzers.

GENERAL TERMS

Spectrum Analyzer — An apparatus generally used to display the power distribution of an incoming signal as a function of frequency.

NOTE

It is useful in analyzing the characteristics of repetitive electrical waveforms in general, since repetitively sweeping through the frequency range of interest will display all components of the signal.

Center Frequency — The frequency that corresponds to the center of a frequency span; expressed in hertz.

dBc — dB below carrier level.

Effective Frequency Range — The range of frequency over which the instrument performance is specified. The lower and upper limits are expressed in hertz.

Full Span (Maximum Span) — A mode of operation in which the spectrum analyzer scans an entire frequency band.

Zero Span — A mode of operation in which the frequency span is reduced to zero.

Envelope Display — The display produced on a spectrum analyzer when the resolution bandwidth is greater than the spacing of the individual frequency components.

Line Display — The display produced on a spectrum analyzer when the resolution bandwidth is less than the spacing of the individual frequency components.

Line Spectrum — A spectrum composed of signal amplitudes of the discrete frequency components.

Maximum Safe Input Power — WITHOUT DAMAGE. The maximum power applied at the input that will not cause degradation of the instrument characteristics.

—WITH DAMAGE. The minimum power applied at the input which will damage the instrument.

Intermodulation Spurious Response (Intermodulation Distortion) — An unwanted spectrum analyzer response resulting from the mixing of the n th order frequencies, due to non-linear elements of the spectrum analyzer. The resultant unwanted response will be displayed.

Baseline Clipper (Intensifier) — Increasing the contrast between the signal and the baseline portion of the display.

Pulse Stretcher — A pulse shaper that produces an output pulse, whose duration is greater than that of the input pulse, and whose amplitude is proportional to that of the peak amplitude of the input pulse.

Signal Identifier — A means to identify the spectrum of the input signal when spurious responses are possible.

Video Filter — A post detection low-pass filter.

Scanning Velocity — Frequency span divided by sweep time and expressed in hertz per second.

TERMS RELATED TO FREQUENCY

Display Frequency — The input frequency as indicated by the spectrum analyzer; expressed in hertz.

Frequency Span (Dispersion) — The magnitude of the frequency band displayed; expressed in hertz or hertz per division.

Frequency Linearity Error — The error of the relationship between the frequency of the input signal and the frequency displayed; expressed as a ratio.

Frequency Drift — Gradual shift or change in displayed frequency over the specified time due to internal changes in the spectrum analyzer; expressed in hertz per second, where other conditions remain constant.

Residual FM (Incidental FM) — Short term displayed frequency instability or jitter due to instability in the spectrum analyzer local oscillators, given in terms of peak-to-peak frequency deviation and expressed in hertz or percent of the displayed frequency.

Impulse Bandwidth — The displayed spectral level of an applied pulse divided by its spectral voltage density level assumed to be flat within the pass-band.

Static (Amplifier) Resolution Bandwidth — The specified bandwidth of the spectrum analyzer's response to a cw (continuous wave) signal, if sweep time is kept substantially long.

NOTE

This bandwidth is the frequency separation of two down points, usually 6 dB, on the response curve if it is measured either by manual scan (true static method) or by using a very low speed sweep (quasi-static method).

Shape Factor (Skirt Selectivity) — The ratio of the frequency separation of the two (60 dB/6 dB) down points on the response curve to the static resolution bandwidth.

Zero Pip (Response) — An output indication that corresponds to zero input frequency.

TERMS RELATED TO AMPLITUDE

Deflection Coefficient — The ratio of the input signal magnitude to the resultant output indication.

NOTE

The ratio may be expressed in terms of volts (rms) per division, decibels per division, watts per division, or any other specified factor.

Display Reference Level — A designated vertical position representing a specified input level.

NOTE

The level may be expressed in dBm, volts, or any other units.

Sensitivity — Measure of a spectrum analyzer's ability to display minimum level signals, at a given IF bandwidth, display mode, and any other influencing factors; expressed in decibels.

Equivalent Input Noise Sensitivity — The average level of a spectrum analyzer's internally-generated noise referenced to the input.

Display Flatness — The unwanted variation of the displayed amplitude over a specified frequency span, expressed in decibels.

Relative Display Flatness — The display flatness measured relative to the display amplitude at a fixed frequency within the frequency span; expressed in decibels.

NOTE

Display flatness is closely related to frequency response. The main difference is that the spectrum display is not recentered.

Frequency Response — The unwanted variation of the displayed amplitude over a specified center frequency range, measured at the center frequency; expressed in decibels.

Display Law — The mathematical law that defines the input-output function of the instrument.

The following cases apply.

- **Linear** — A display in which the scale divisions are a linear function of the input signal voltage.
- **Square law (power)** — A display in which the scale divisions are a linear function of the input signal power.
- **Logarithmic** — A display in which the scale divisions are a logarithmic function of the input signal voltage.

Dynamic Range — The maximum ratio of the levels of two signals simultaneously present at the input which can be measured to a specified accuracy.

Display Dynamic Range — The maximum ratio of the levels of two non-harmonically related sinusoidal signals; each of which can be simultaneously measured on the screen to a specified accuracy.

Gain Compression — Maximum input level where the scale linearity error is below that specified.

Spurious Response — A response of a spectrum analyzer where the displayed frequency does not conform to the input frequency.

Hum Sidebands — Undesired responses created within the spectrum analyzer, appearing on the display, that are separated from the desired response by the fundamental or harmonic of the power-line frequency.

Noise Sidebands — Undesired response caused by noise internal to the spectrum analyzer appearing on the display around a desired response.

Residual Response — A spurious response in the absence of an input signal. (Noise and zero pip are excluded.)

Input Impedance — The impedance at the desired input terminal, usually expressed in terms of vswr, return loss, or other related terms for low impedance devices and resistance-capacitance parameters for high-impedance devices.

TERMS RELATED TO DIGITAL STORAGE

Stored Display — A display method whereby the displayed function is held in a digital memory. The display is generated by reading the data out of memory.

Digitally Averaged Display — A display of the average value of digitized data computed by combining serial samples in a defined manner.

Multiple Display Memory — A digitally-stored display with multiple memory sections that can be displayed separately or simultaneously.

Clear (Erase) — Presets memory to a prescribed state, usually that denoting zero.

Save A — A function that inhibits storage update, saving existing data in a section of a multiple memory (e.g., Save A).

View (Display) — Enables viewing of contents of the chosen memory section (e.g., View A displays the contents of memory A; View B displays the contents of memory B).

Max Hold (Peak Mode) — Digitally stored display mode that compares, at each frequency address, the incoming signal level to the stored level and retains the greater. In this mode, the display indicates the peak level at each frequency after several successive sweeps.

Scan Address — A number representing each horizontal data position increment on a directed beam type display. An address in a memory is associated with each scan address.

TERMS RELATED TO MARKERS

Live Trace — Any combination of the A trace and/or the B trace when SAVE A is off.

Active Trace — Live Trace or the B-SAVE A trace (a trace recalled into B is not an active trace).

Inactive Trace — SAVE A trace or a trace recalled into the B display before the sweep is started.

Primary Marker — The marker displayed in the Single Marker mode whose frequency and/or position is changed when tuning with the CENTER/MARKER FREQUENCY control. When two markers are displayed, the brightest marker is the Primary marker.

Secondary Marker — The "second" marker; displayed only in the Delta Marker mode.

*This Document is a complete Scan from the original
Tektronix manual
For enquiries about our complete
High quality line of technical Manuals in PDF
mailto : Qservice@otenet.gr*

**SEE
OTHER
SIDE**

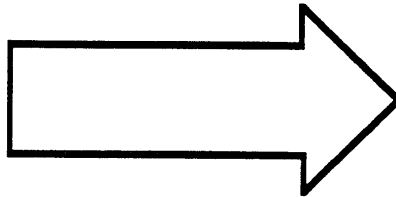

MANUAL CHANGE INFORMATION

At Tektronix, we continually strive to keep up with latest electronic developments by adding circuit and component improvements to our instruments as soon as they are developed and tested.

Sometimes, due to printing and shipping requirements, we can't get these changes immediately into printed manuals. Hence, your manual may contain new change information on following pages.

A single change may affect several sections. Since the change information sheets are carried in the manual until all changes are permanently entered, some duplication may occur. If no such change pages appear following this page, your manual is correct as printed.